



ugo basile®

TRANSFORMING IDEAS INTO INSTRUMENTS

instruction manual

BP RECORDER

Cat. No. 58500-58550-58600



UGO BASILE S.R.L.

sales@ugobasile.com / service@ugobasile.com www.ugobasile.com

UGO BASILE S.R.L.

Via Di Vittorio, 2
21036 GEMONIO, VA, ITALY
Phone: +39 0332 744574

sales@ugobasile.com / service@ugobasile.com
www.ugobasile.com

instruction manual

BP RECORDER
Cat. No. 58500-58550-58600

Serial No.

SAFETY CONSIDERATIONS

ALTHOUGH THIS INSTRUMENT HAS BEEN DESIGNED WITH INTERNATIONAL SAFETY STANDARD, THIS MANUAL CONTAINS INFORMATION, CAUTIONS AND WARNINGS WHICH MUST BE FOLLOWED TO ENSURE SAFE OPERATION AND TO RETAIN THE INSTRUMENT IN SAFE CONDITIONS.

SERVICE AND ADJUSTMENTS SHOULD BE CARRIED OUT BY QUALIFIED PERSONNEL, AUTHORIZED BY UGO BASILE ORGANIZATION.

ANY ADJUSTMENT, MAINTENANCE AND REPAIR OF THE OPENED INSTRUMENT UNDER VOLTAGE SHOULD BE AVOIDED AS MUCH AS POSSIBLE AND, WHEN INEVITABLE, SHOULD BE CARRIED OUT BY A SKILLED PERSON WHO IS AWARE OF THE HAZARD INVOLVED.

CAPACITORS INSIDE THE INSTRUMENT MAY STILL BE CHARGED EVEN IF THE INSTRUMENT HAS BEEN DISCONNECTED FROM ITS SOURCE OF SUPPLY.

Blood Pressure Recorder (non-invasive)

Cat. No. 58500 for Rats
Cat. No. 58600 for Mice
Cat. No. 58550 for Rats & Mice

General

The BP RECORDER 58500 combines three main systems

- pressure generation-pressure monitoring system
- a pulse amplifier and
- a thermal-array analog & digital recording unit

with two auxiliary systems

- pulse rate measuring and recording
- microprocessor controlled functions to self diagnosis, calibration, signal filtering, signal storage.

Instrument Description

Pressure is transmitted to the tail cuff; as soon the cuff pressure exceeds the diastolic pressure and starts to narrow the tail artery, the amplitude of the recorder pulse wave gradually decreases until the artery is completely constricted (ischemic), the graph becoming a straight line.

This point indicates the maximum internal pressure of the artery (**systolic pressure**) on the paper grid, on which the **actual pressure** of the system is **digitally printed in 10 mm Hg steps**.

At the end of the recording a second pressure measurement can be started, with decreasing pressure. The systolic pressure is indicated, this time, by the return of the pulse tracing.

The animal **pulse rate** can be assessed in real time by a pulse rate counter which picks the signal from the pulse transducer.



INDIRECT MEASURING & RECORDING OF THE
SYSTOLIC AND DIASTOLIC PRESSURE
IN UNANAESTHETIZED RATS & MICE

Main Features

- graphic printer
- graphic display
- analog output to digital recorders
- pulse transducers of superior performances
- analogue & digital recording of all experiment phases
- reliable pressure generator, providing smooth, stepless pressure build-up



ugo basile®
TRANSFORMING IDEAS
INTO INSTRUMENTS

CHECK-LIST

- CAT: 58500 BP Recorder for Rat**
 CAT: 58600 BP Recorder for Mouse
 CAT: 58550 BP Recorder for Rats and Mice

CLIENTE / CUSTOMER _____

No. Ordine / Order No. _____ Data / Date ____ / ____ / ____

UB code	CAT.No.	✓	Q.ty	DESCRIPTION
E-WP 008		<input type="checkbox"/>	1	EUROPA
E-WP 008-1		<input type="checkbox"/>		MAINS CABLE
E-FT 002-1		<input type="checkbox"/>	2	FUSES FOR 115V (T 630 MA)
E-FT 004-1		<input type="checkbox"/>	2	FUSES FOR 230 V (T 315 MA)
	52050-08	<input type="checkbox"/>	1	CD CUB
	52010-322	<input type="checkbox"/>	1	CONNECTING CABLE 9 TO 9 PIN
STANDARD SET FOR 58500	58000-508	<input type="checkbox"/>	1	8 mm PULSE PICK-UP
	58000-613		1	13 mm PRESSURE CUFF WITH SET OF O-RINGS & SET OF 5 MEMBRANES
	58000-345		1	RAT HOLDER, 50 mm
STANDARD SET FOR 58600	58000-503	<input type="checkbox"/>	1	3 mm PULSE PICK-UP
	58000-606		1	6 mm PRESSURE CUFF WITH SET OF O-RINGS & SET OF 5 MEMBRANES
	58000-343		1	MOUSE HOLDER 30 mm DIAM.
STANDARD SET FOR 58550	58000-508	<input type="checkbox"/>	1	8 mm PULSE PICK-UP
	58000-613		1	13 mm PRESSURE CUFF WITH SET OF O-RINGS & SET OF 5 MEMBRANES
	58000-345		1	RAT HOLDER, 50 mm
	58000-503		1	3 mm PULSE PICK-UP
	58000-606		1	6 mm PRESSURE CUFF WITH SET OF O-RINGS & SET OF 5 MEMBRANES
	58000-343		1	MOUSE HOLDER 30 mm DIAM.
ADDITIONAL OPTIONAL ACCESSORIES1				
	58000-504	<input type="checkbox"/>		4 mm PULSE PICK-UP MOUSE
	58000-505	<input type="checkbox"/>		5 mm PULSE PICK-UP RAT
	58000-506	<input type="checkbox"/>		6 mm PULSE PICK-UP RAT
	58000-507	<input type="checkbox"/>		7 mm PULSE PICK-UP RAT
	58000-509	<input type="checkbox"/>		9 mm PULSE PICK-UP RAT
	58000-609	<input type="checkbox"/>		9 mm PRESSURE CUFF FOR RAT
	58000-344	<input type="checkbox"/>		RAT HOLDER 40 mm DIAM.
	58000-346	<input type="checkbox"/>		RAT HOLDER 60 mm DIAM.

DATE / /	Serial No.	PREPARATO DA / PACKED BY
Set for <input type="checkbox"/> 115V 50 Hz <input type="checkbox"/> 230V 50 Hz <input type="checkbox"/> 115V 60 Hz <input type="checkbox"/> 230V 60 Hz		

IMPORTANT/IMPORTANTE:

Check the shipment for completeness immediately after receipt: should you find any discrepancy, please fill in the following part and transmit it to our fax No. **+39 0332 745488**

Al ricevimento della merce controllate che la spedizione sia completa: in caso di discrepanza, completate il formulario di seguito riportato ed inviatelo al nostro fax No. **0332 745488**

FROM: Name _____ Company/Institution _____

DATE _____ REF. _____

NOTES



CONTENTS

1	INTRODUCTION	1
2	INSTRUMENT DESCRIPTION	2
2.1	PRESSURE GENERATOR SYSTEM	2
2.2	COMMAND OVERVIEW	4
2.3	CHART RECORDER	5
2.4	TAIL CUFFS	6
2.5	PULSE TRANSDUCERS	6
2.6	ANIMAL RESTRAINERS	7
2.7	OPTIONAL ANIMAL HEATER /SCANNER	7
3	DATA ACQUISITION	8
4	INSTALLATION	8
4.1	UNPACKING & PRELIMINARY CHECK	8
4.2	NOTES ON THE INSTRUCTION MANUAL	9
4.3	BEFORE APPLYING POWER	9
4.3.1	<i>MAINS SWITCH</i>	9
4.3.2	<i>FUSE HOLDER & VOLTAGE SELECTOR</i>	10
4.3.3	<i>MAINS CORD</i>	10
4.4	CONNECTIONS	10
4.5	ADDITIONAL SAFETY CONSIDERATION	11
5	PRELIMINARY	11
5.1	PRE-WARMING THE ANIMAL (RAT & MOUSE)	11
5.2	RESTRAINING THE RODENT	12
5.3	CONDITIONING THE RODENT	12
5.4	SWITCHING ON	13
5.5	INITIAL "DRY RUN"	13
6	OPERATION	14
6.1	MODE MENU	14
6.1.1	<i>MEASUREMENT SELECTION</i>	14
6.1.2	<i>SPEED SELECTION</i>	15
6.1.3	<i>ANIMAL SELECTION</i>	15
6.1.4	<i>SET REVERSE PRESSURE</i>	16
6.1.5	<i>SET REVERSE TIME</i>	16
7	TEST MENU	16



7.1	AUTOMATIC MEASUREMENT	17
7.2	MANUAL MEASUREMENT	17
7.3	STARTING THE PRESSURE MEASUREMENT	18
8	<u>CALIBRATION</u>	20
9	<u>DATA PRINT-OUT AND OUTPUT TO THE PC</u>	21
9.1	HOW TO SET THE DATA OUTPUT	21
9.2	INSTRUMENT ADDRESS AND BAUD-RATE	22
9.3	HOW TO SET A CUSTOMIZED EXPERIMENTAL CONFIGURATION	23
9.3.1	<i>SEQUENCE NUMBER</i>	23
9.3.2	<i>ANIMAL GENDER</i>	24
10	<u>QUICK SETTING OF THE BP RECORDER</u>	24
11	<u>MEMORY MANAGEMENT</u>	25
11.1	MEMORY RESET	26
11.1.1	<i>"MEMORY FULL" MESSAGE</i>	27
11.2	SETTING TIME & DATE	27
11.3	DISPLAY CONTRAST	28
12	<u>MAINTENANCE</u>	28
12.1	ELECTRICAL	29
12.2	REPLACING A LEAKY PRESSURE CUFF MEMBRANE	29
12.3	REPLACING THE PAPER ROLL	29
12.4	LONG INACTIVITY	30
12.5	CUSTOMER SUPPORT	30
13	<u>ORDERING INFORMATION</u>	31
13.1	AVAILABLE PULSE PICK-UPS	31
13.2	AVAILABLE TAIL CUFFS	32
13.3	AVAILABLE HOLDERS	32
13.4	ACCESSORIES AND CONSUMABLES	32
13.5	OPTIONAL	32
13.6	SPECIFICATIONS	33
14	<u>BIBLIOGRAPHY</u>	33

FIGURE INDEX

Figure 1 "Pressure Generator"	2
Figure 2 "Pneumatic Circuit"	3
Figure 3 "Sample of a Graph"	4
Figure 4 "Front Panel"	4
Figure 5 "Tail Cuff"	6
Figure 6 "Pulse Transducer"	6
Figure 7 "Rat Holder"	7
Figure 8 "Rat Scanner"	8
Figure 9 "Power Module"	9
Figure 10 "Back Panel"	10
Figure 11 "Paper Roll"	30



BP RECORDER

FOR INDIRECT MEASURING AND RECORDING OF BLOODLESS PRESSURE IN UN-ANAESTHETIZED RATS AND MICE

SERIES 58000

1 INTRODUCTION

Our **BP Recorders series 58000** have been conceived to provide an objective precise recording of the systolic and diastolic pressure of rodents.

This new model, housed in an attractive cabinet of original design, is provided with:-

- graphic printer
- graphic display
- serial port RS232C
- analog output for direct connection to most digital recorders (as PowerLab) for data acquisition and management

Its paramount features are:-

- i) a set of pulse transducers of superior performance
- ii) a reliable pressure generator which provides a very smooth (stepless) pressure build-up
- iii) an analog and digital recording of all the phases of the experiment

The 58500 combines together three main systems:-

- 1) pressure generation-pressure monitoring system
- 2) pulse amplifier
- 3) thermal-array analog & digital recording unit

and two auxiliary systems:-

- 4) pulse rate measuring and recording
- 5) microprocessor controlled functions of self diagnosis, calibration, signal filtering, signal storage

2 INSTRUMENT DESCRIPTION

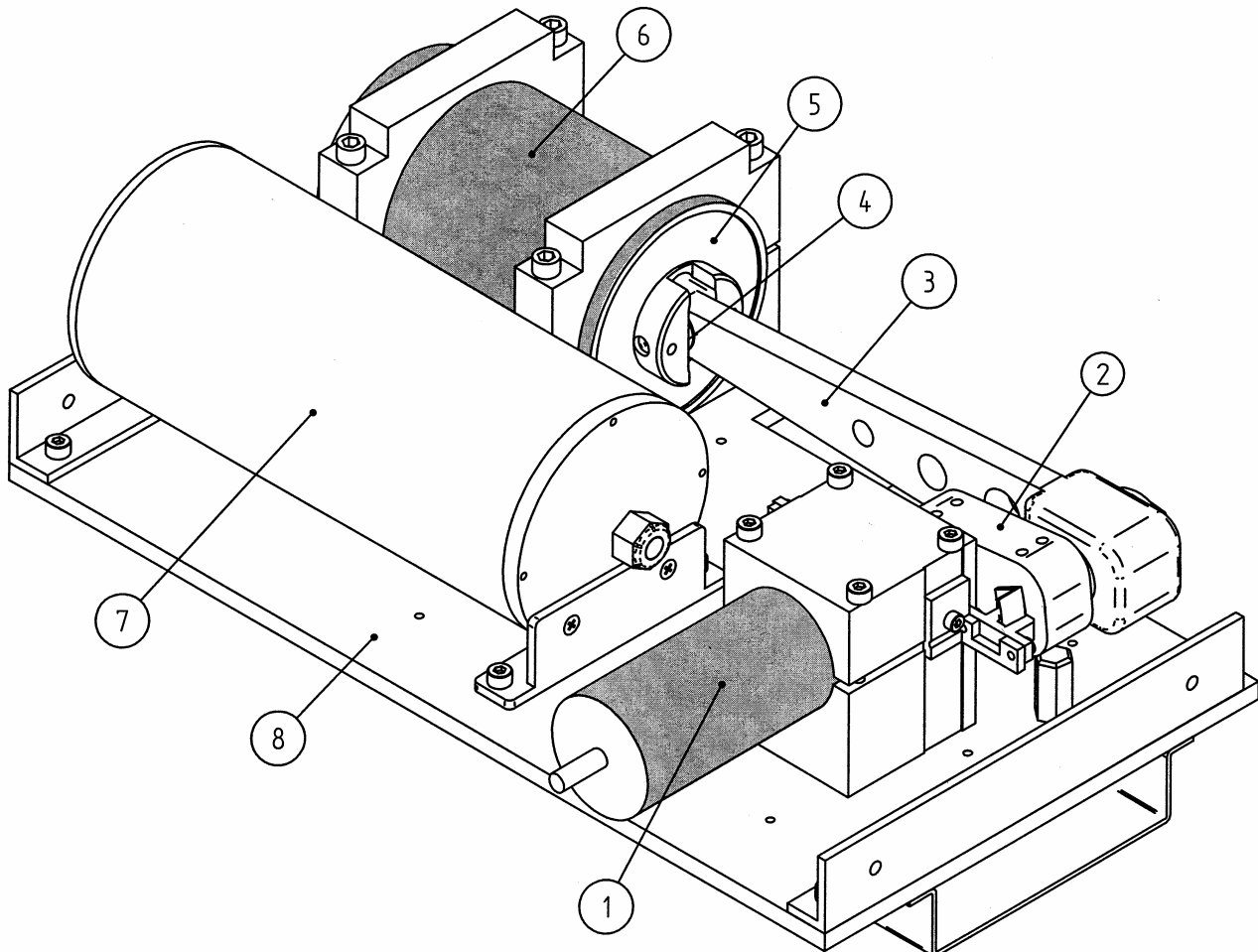

Figure 1 "Pressure Generator"

2.1 Pressure Generator System

A geared motor (1), via a crank-link-gudgeon (2, 3, 4) causes the forward and reverse motion of a piston (5) into a stationary cylinder (6), see Figure 1 "Pressure Generator". This pressure generating mechanism is fastened to a sturdy aluminium plate (8).

The pressure is transmitted via an appropriate piping (13) to an expansion vessel (7), a blow-out valve (9), a pressure gauge (10) and the tail cuff (12) through the pneumatic connection (11), see Figure 2 "Pneumatic Circuit".

The cuff pressure increases until it exceeds the diastolic pressure and starts to constrict the tail artery (*arteria caudalis*). The amplitude of the recorded pulse wave decreases until the artery is completely constricted (*ischemic*) and the graph becomes a straight line.

When the operator selects the "compression measurement" only, a point indicates on the paper grid the maximum internal pressure of the artery (**systolic pressure**).



The piston motion reverses and the decompression phase begins. The systolic pressure is indicated, this time, by the return of the pulse trace.

The pulse rate of the animal is automatically assessed in real time by a pulse rate counter which picks the signal from the pulse transducer.

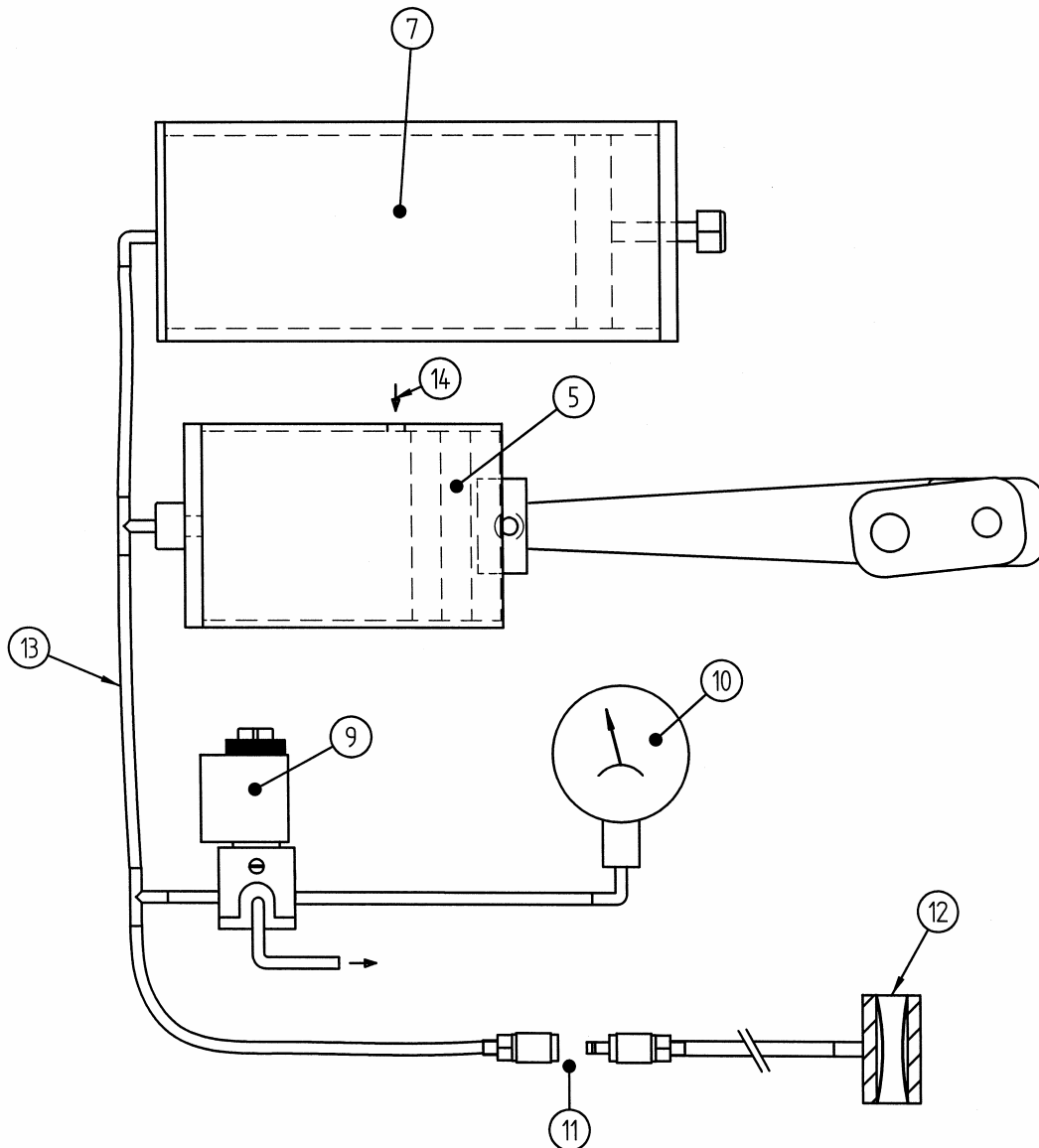

Figure 2 "Pneumatic Circuit"

In both compression and decompression runs, even the **diastolic, if selected**, is recorded as the pressure at which the pulse shows an unmistakable transition from steady to decreasing amplitude.

See Figure 3 "Sample of a Graph" and more details about graph and captions on paragraph 7.3-Starting the Pressure Measurement.

You will notice the pressure indications are sets of three digits, e.g., 070 – 130 – 180, marked on the lower edge of the recording chart in vertical pattern, for economy of space, as in the Chinese signs.



In fact, the recorder status and functions are set-up automatically and visualized via the display.

The dedicated keys

- **RED** (DECOMPRESSION, which releases the pneumatic system and causes the piston to speed back to its starting point, when depressurization is necessary, see paragraph 2.4-Tail Cuffs).
- **BLUE** (START/REVERSE, see paragraph 7.3-Starting the Pressure Measurement)

and the four functional keys

- **F1-F2-F3-F4**

are the only operational commands.

The display and the functional keys combine to program the trial parameters selected by the operator, to communicate the status of the experiment, any warning message, etc., see following subheadings.

The upper rectangular window brings the linkage in sight and reassures the operator that the pressure generator is doing its job.

2.3 Chart Recorder

This high-resolution, 50mm, real-time thermal printer of GSI LUMONICS, located on the left side of the upper panel, has been selected as it offers a number of new features, including warning messages to notify the user of undesirable conditions, thus preventing errors.

See Figure 11 "Paper Roll", self-explanatory on what concerns the replacement of the chart roll.

The XE-50 communicates through a serial interface at 115,000 bits per second: when in recorder mode it prints a simultaneous real-time waveform along with background grid, text, and graphics.

The table below lists some specs. of this remarkable chart recorder:-

Printing method	:	direct, thermal
Print resolution	:	600 dots per 25 mm
Drive type	:	stepper motor
Chart specs.	:	2-inch thermal roll paper, 100 ft length
Chart speed	:	selectable
Chart skew	:	± 0.5 mm maximum over any 10 s interval, after first 150
Accuracy	:	$\pm 2\%$



2.4 Tail Cuffs

The rat and mouse tail cuffs, available in different diameters (see 13.2-Available Tail Cuffs) are of simple and straightforward design: they combine a sturdy short plastic-tube, a rubber membrane and two O-rings (see 13.4-Accessories and Consumables, for spares) to seal the annular pressure chamber.

The cuff is provided with a stretch of Tygon tube featuring a pneumatic snap-in connector to couple it to the BP Recorder.

See also paragraph 12.2-Replacing a Leaky Pressure Cuff Membrane for fitting and replacing the membranes.

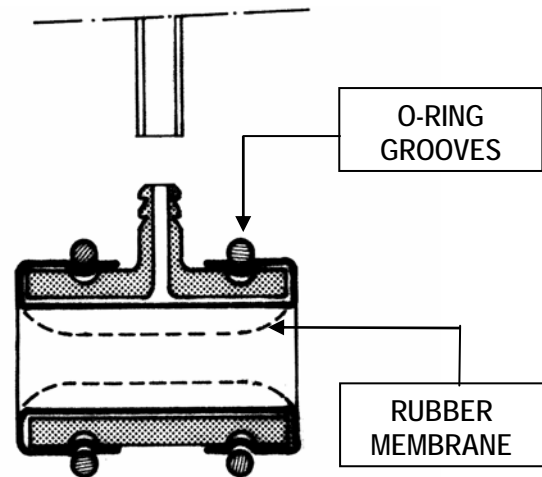

Figure 5 "Tail Cuff"

Incidentally, to free the animal from the tail-cuff without hurting it or damaging the rubber membrane, requires the cuff to be *deflated*.

To depressurize, push the red key **DECOMP**: this causes the solenoid valve (9) to open, releasing the pneumatic system, and the piston to speed back to its starting point.

2.5 Pulse Transducers

The pulse transducer, or pulse pick-ups, available in different diameters (see 13.1-Available Pulse Pick-ups) are basically piezoceramic rings.

They fit the tails of the animals and are "stressed" by the rhythmical expansion caused by the systolic waves.

It is known that the stress causes a piezoelectric element to generate a proportional voltage; in our pulse transducers this voltage is led to the amplifier by a miniature coaxial cable.

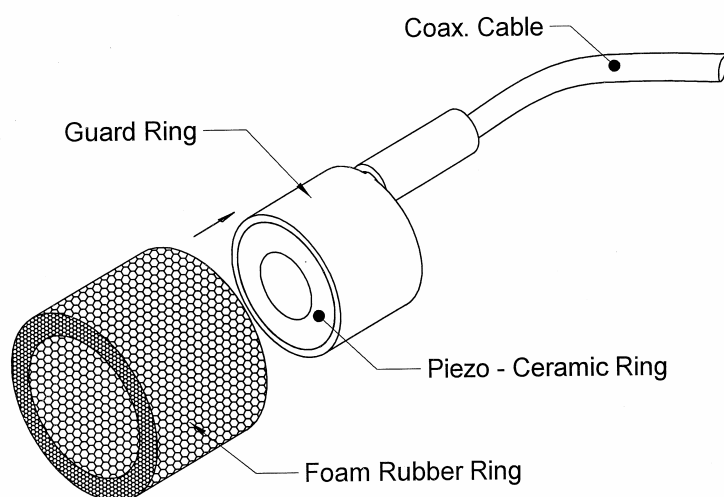

Figure 6 "Pulse Transducer"

An expendable foam rubber ring reduces the mechanical shocks brought about by the tail movements and thus minimizes any spurious signals.



2.6 Animal Restrainers

Convenient animal restrainers are provided with the standard package. Our models are particularly suitable, see Figure 7 “Rat Holder”, being purposefully designed for this task, as they feature:-

- a) a conical “muzzle” to confine the animal head
- b) availability in 3 different diameters for rat and one for mouse, to fit various animal sizes (see 13.3-Available Holders).
- c) telescope-adjustable length
- d) a quick fit/release back lid provided with an ample U-shaped tail slot
- e) capability of dissipating the rat body heat by a suitable combination of ventilation slots, selection of heat conductive materials, etc.



Figure 7 “Rat Holder”

See also paragraph 5.2-Restraining the Rodent.

2.7 Optional Animal Heater /Scanner

The **58000-850 Rat Scanner** is a compact temperature controlled “cupboard” which can house 5 rats, each in its individual holder, for pre-warming the animals, see paragraph 5.1, and scanning their BP measures.

The tail cuff and pulse pick-up can be positioned on the animal tail.

A double switch (electrical/pneumatical) enables the operator to connect the holders in sequence to the BP Recorder, to “scan” the blood pressure of up to 5 rodents.



A more economical version, Cat. **58000-845**, without the pneumatic/electrical scanning provision, is also available, when only pre-warming is required.

The **58000-840**, designed for mice, has the same dimensions, but it accommodates 6 mouse holders.

See paragraph 13.5-Optional.



Figure 8 "Rat Scanner"

3 DATA ACQUISITION

The 58500 BP Recorder is microprocessor controlled and features direct PC output. Internally-stored data can be routed via 9-pin D-type connector to the PC serial port (RS232) see paragraph 9-DATA PRINT-OUT AND OUTPUT TO THE PC.

Serial communication between 58500 BP Recorder and an IBM (or compatible) PC is controlled by Ugo Basile Win-DAS Software Cat. 52010 supplied as optional. See 13.5-Optional.

The 52010 is a Windows[®] based Data Acquisition Software Package, which enables the research worker to store the data into individual files, ready to be easily managed by most statistical analysis packages available on the market. **Ask for details: a free demo diskette is available!**

4 INSTALLATION

4.1 Unpacking & Preliminary Check

Check the contents of the shipment for completeness, packing list to hand, and visually inspect the instrument as soon you take it out of the packaging. Use the **Check List** supplied.

If the instrument is damaged or, after having tested it, fails to meet rated performances, notify the carrier and our company immediately.



Protect the environment!

Dispose of packaging properly, according to existing and applicable waste management rules and regulations.

4.2 Notes on the Instruction Manual

The BP Recorder Instruction Manual included in accessory package is necessary for the correct installation and operation of the instrument.

We recommend keeping the manual in good condition, ready to be consulted by the qualified personnel who use the instrument.

Free of charge copies of the instruction manual are available upon request: please contact our service department (see paragraph 12.5- Customer Support) specifying the series number of your instrument.

4.3 Before Applying Power

Position the instrument on a stable and flat bench or table surface.

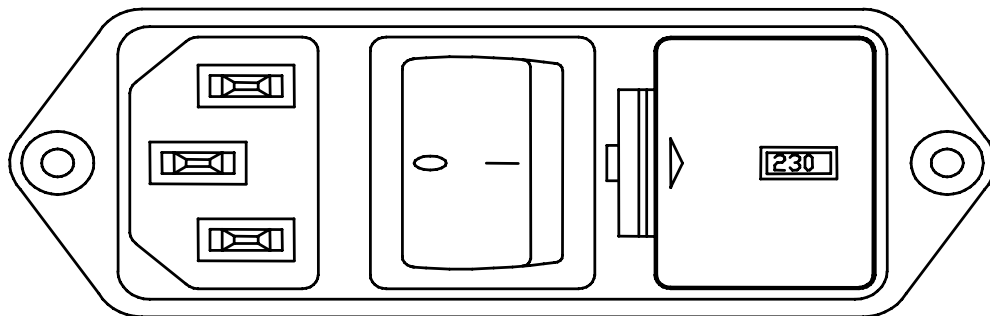

Figure 9 "Power Module"

Take a look at the Power Module, on the back of the instrument, which encompasses – from left to right - the inlet connection of the mains cord, the mains switch and the fuse holder/voltage selector.

4.3.1 Mains Switch

This two-pole toggle switch, which complies with international safety standards, provides a visual cue, meaning:-

- **OFF** when pressed to the "O" side
- **ON** when pressed to the "I" side



4.3.2 Fuse Holder & Voltage Selector

The fuse holder comprises two fuses, one on the live, and the other on the neutral. For operation at 230-240 Volts, we recommend 315 mA timed "slow blow" fuses (type T315). Use 630 mA fuses (type T630) for operation at 115 Volts.

The fuse holder also embodies the Voltage Selector. Make sure that the label visible in the window indicates the correct voltage (i.e., the voltage of your mains).

To replace the fuses and/or change the selected voltage, see paragraph 12.1-Electrical.

4.3.3 Mains Cord

It is a standard cable, Cat. # E-WP008. Make sure your power outtake is provided with a reliable ground connection, see also 4.4 & 4.5.

4.4 Connections

Connect the mains cord to a power outtake, **provided with a reliable earth connection.**

Beside the power module described in paragraph 4.3, the BP Recorder back panel encompasses the following connectors, from left to right:-

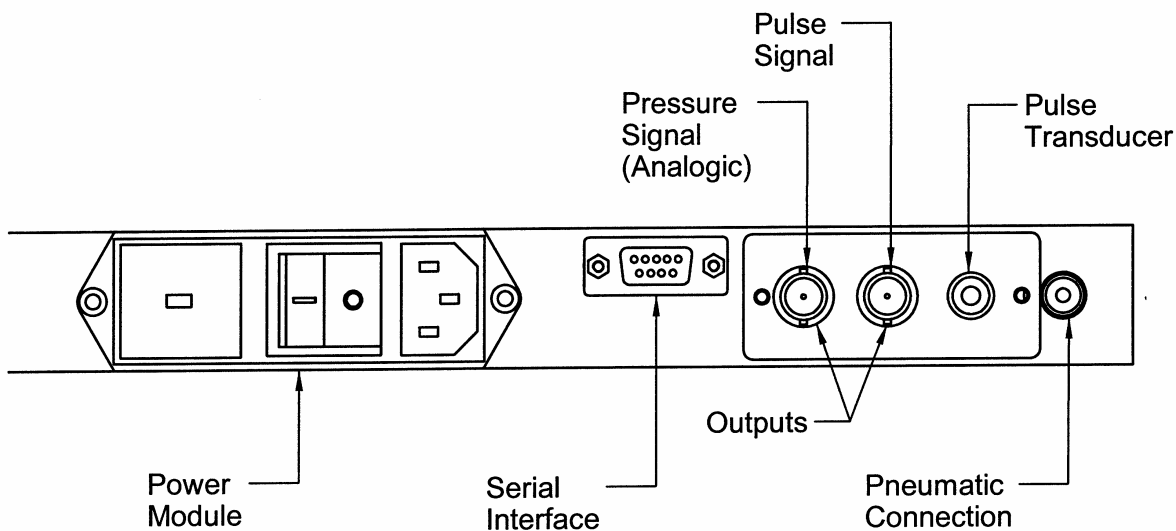

Figure 10 "Back Panel"

SERIAL INTERFACE: this delta 9-pin connector enables the operator to connect the instrument to the serial port RS232C of the PC, see paragraph 3-DATA ACQUISITION.

PRESSURE SIGNAL (ANALOGIC): these connectors are useful to route both pressure and pulse signals to CRT (oscilloscope), chart recorder or PC (via a data acquisition system)

PULSE SIGNAL:



PULSE TRANSDUCER: for connection of the selected transducer, see paragraph 2.5.

PNEUMATIC

CONNECTION: for connection of the selected cuff, see paragraph 2.4.

4.5 Additional Safety Consideration

- a. Place your BP Recorder on a steady flat surface.
- b. Do not obstruct free and comfortable access to the power module.
- c. Use original accessories and spare parts only, see also paragraph 13-ORDERING INFORMATION.
- d. Immediately disconnect and replace an accidentally damaged mains cable.
- e. Do not operate the BP Recorder in hazardous environments or outside prescribed environmental limitations (i.e. 10°C / +40°C, 95% relative humidity, non-condensing).
- f. Do not spray any liquid on the connectors.

UGO BASILE DOES NOT ACCEPT ANY RESPONSIBILITY FOR PROBLEMS OR HARM CAUSED TO THINGS OR PERSONS ARISING FROM:



- ◆ INCORRECT ELECTRICAL SUPPLY.
- ◆ INCORRECT INSTALLATION PROCEDURE.
- ◆ INCORRECT OR IMPROPER USE OR, IN ANY CASE, NOT IN ACCORDANCE WITH THE PURPOSE FOR WHICH THE INSTRUMENT HAS BEEN DESIGNED AND THE WARNINGS BROUGHT TO YOUR ATTENTION IN THE INSTRUCTION MANUAL SUPPLIED WITH THE INSTRUMENT.
- ◆ REPLACEMENT OF ORIGINAL COMPONENTS, ACCESSORIES OR PARTS WITH OTHERS NOT APPROVED BY THE MANUFACTURER.
- ◆ SERVICING CARRIED OUT BY UNAUTHORIZED PERSONNEL.

5 PRELIMINARY

5.1 Pre-warming the Animal (Rat & Mouse)

Place the animal in a warming cupboard, at about 29-30°C for at least 30 minutes, in order to cause a sufficient vasodilation in the caudal artery. We recommend our models, purposefully designed for this task, see 2.7-Optional Animal Heater /Scanner.

Some researchers feel that in this way the vasodilation of the whole vascular system will inevitably cause a “pressure drop”. This pressure drop takes place in all animals and consequently the reliability of a pressure screening should not be severely affected. Admittedly, this reasoning may leave some scientists uncomfortable about the artefact he/she feels it may impair the experiment.



As alternative, it is suggested to prewarm at lower temperature, say, 26-27°C which, after all, is not worse than a hot Summer day, and then apply local heating.

Once the animal is restrained in its harness, apply on the protruding tail the heat source, which can be an infrared bulb, a heating blanket or both.

Care should be taken to avoid overheating which may cause the animal a severe discomfort and consequent struggling, etc. A warm jacket-tube in which the tail is inserted has proven to be good.

Bear in mind that the vasodilation which makes the pulse “audible” to the transducer is a threshold process. In particular, when the local heating method is followed, the pulse may be totally missing at the “TEST interrogation” and pops out loud and clear twenty seconds later.

Once a satisfactory vasodilation is achieved, the heat source can be removed or reduced. A minimum of practice (and persistence!) will overcome all problems.

According to our knowledge, every researcher using the BP Recorder has perfected the technique, adding each his/her personal touch to optimize technique for lab or application.

5.2 Restraining the Rodent

Basically, rats and mice are placed into suitable harnesses from which the tail protrudes. The rat and mouse holders available on the market or already in use at your laboratory may prove to be convenient.

Our models, being purposefully designed for this task, are particularly suitable, see 13.3-Available Holders and Figure 7 “Rat Holder”.

5.3 Conditioning the Rodent

Some research workers think advisable to carry out some kind of “conditioning”, before starting the blood pressure measurement.

In other words, the animals should be kept 3-4 minutes in the restrained conditions, their tails fitted with cuff and transducer, better if the exercise is repeated 2-3 times a day. It is obvious they will behave in a more relaxed way, in particular from the cardio-vascular perspective, when the “real thing” will eventually take place!

Operate with patience and remember that more patience and longer familiarization time are required when handling mice. These small creatures seem to be constantly in motion, twisting and turning, particularly when you confront them with a fresh mouse holder.



5.4 Switching On

Switch on the instrument. Momentarily, the display will read "V01" (firmware version 01) according to the following picture:

The top line (now 000) indicates the **actual pressure** in the tail cuff.

The second line shows the **heart rate** in pulses per minute. This figure can be 000, or a value recorded in a previous experiment may be displayed.

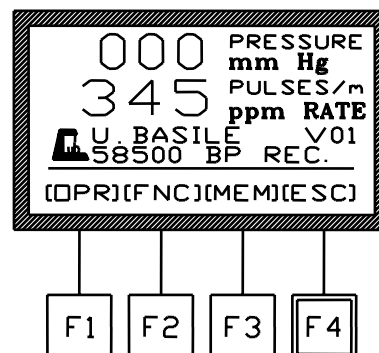

The caption below the second line shows the logo, the manufacturer's name, the firmware version (actually V01) and the catalogue number of the instrument.

The bottom line illustrates the **key functions**.

Depress the key **F4 (ESC)**; the following displays will appear in loop-mode succession:-

You will notice a change only in the 3rd and 4th line which form a small-type double string. The top string shows, in order, systolic, diastolic pressure and heart rate in the **compression phase**.

The bottom string shows the same data, in the same sequence, but related to the **decompression phase**.

The M01 characters represent complementary information, which will be described later on.

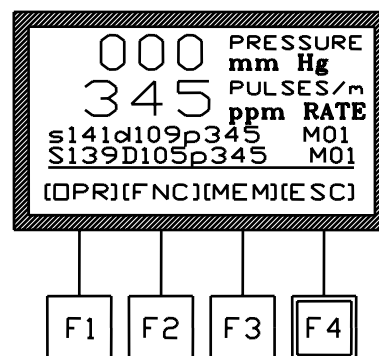

By depressing the F4 key again the display shows the present time and date, once more and the two mice (logo of our flyers) show up!

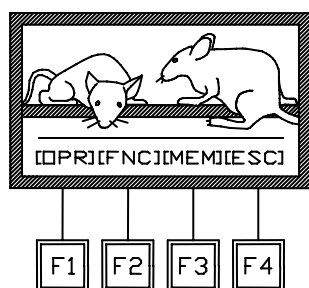

Our attention is now directed to the key functions:-

- **OPR** (OPERATION)
- **FNC** (FUNCTION)
- **MEM** (MEMORY)
- **ESC** (ESCAPE)

5.5 Initial "Dry Run"

A "dry run" is advisable, to get familiar with the instrument, neglecting for the moment the animal which will otherwise drive all available attention.

Connect both the selected pulse transducer and pressure cuff, see paragraph 4.4-Connections.



WARNING: it is advisable to insert a small cylinder (a fountain pen has the appropriate diameter) into the cuff, to prevent a possible burst of the membrane when the pressure builds up during dry-run test..

Switch on. Bear in mind that we have not the animal and therefore the pulse transducer does not supply any signal.

IMPORTANT!

For a preliminary check, depress **F1** three times (**OPR – TES – AUT**), wait a couple of seconds and then pick-up the transducer, hold it between forefinger and thumb and gently shake it. The resulting inertial forces mimic the tail pressure signal.

Note the central dot over the bottom caption of the display on which you will read “**REPEAT TEST**”. In fact, the instrument is designed to operate with the animal and its logic circuit “thinks” that something is wrong.

When you shake the transducer, the dot enlarges to form a dash whose length is proportional to the amplitude of the signal. To check the pneumatic part of the business, depress from the main menu **F1 (OPR)** and **F3 (CAL)** and then **START**, again **F1**. Read the attained pressure. Stop the compression phase via **F2 (STP)**. At the end of the test, depress **F4 (NUL)**.

6 OPERATION

From the MAIN MENU, depress the **F1 (OPR)** key. The small-type double-string line, generally related to the key functions, changes and you read:-

- **TES** (TEST) (see paragraph 6.1.5)
- **MOD** (MODE) (see paragraph 0)
- **CAL** (CALIBRATION) (see paragraph 8)
- **ESC** (ESCAPE)

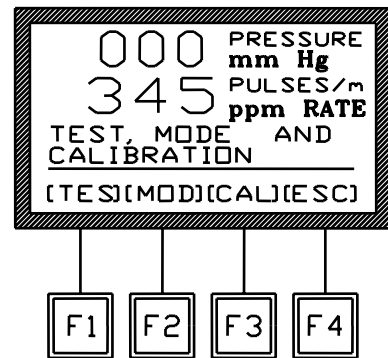

As shown in the display at this side, which illustrates the fresh function of the keys.

6.1 Mode Menu

Depress **F2**. The display indication enables you to set the mode of operation you have selected.

6.1.1 Measurement Selection

F1 (MEA) presets the instrument to record the systolic and diastolic pressure, taking note of the used abbreviations.



- UP/DOWN** the pressure measurements are taken during the compression phase (**UP**) and the decompression (**DOWN**) phase;
- DIA/SYS** the instrument is set to record both diastolic & diastolic pressure;
- SYS** the instrument measures the systolic pressure only.

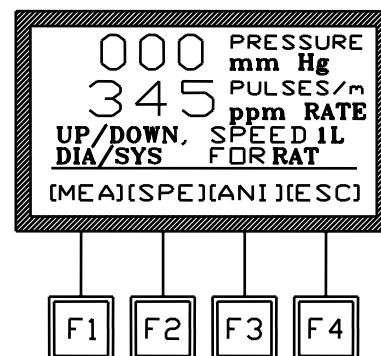

By depressing F1 (**MEA**) in repetition, the operator selects the desired mode according to the following four combinations:-

- | | | | |
|----------|---------|---|---------|
| 1 | UP/DOWN | - | DIA/SYS |
| 2 | DOWN | - | DIA/SYS |
| 3 | UP/DOWN | - | SYS |
| 4 | DOWN | - | SYS |

6.1.2 Speed Selection

Now, let us consider the speed (**F2 SPE**). There are two speeds: **first, the speed at which the pressure increases**, obviously proportional to the traverse speed of the piston (see paragraph 2.1-Pressure Generator System). For a first run, you should select :

- SPEED 1** of 10 mm Hg/second
- or
- SPEED 2** of 20 mm Hg/second.

The **second** speed refers to the **chart motion** (in millimetres per second):

- L low**, of **5** mm/s (SPEED 1) or **10** mm/s (SPEED 2)
- and
- H high**, of **10** mm/s (SPEED 1) or **20** mm/s (SPEED 2)

Via the appropriate speed selection, the pressure graph (see Figure 3 "Sample of a Graph") does not appear too thin or too tight.

This is far from being a simple question of look! As we will see, an appropriate tightness of the graph (see displays at pages 18/19) helps the operator to pinpoint the systolic pressure with exactitude.

6.1.3 Animal Selection

Depress the **F3 (ANI)** key in succession. On the bottom line you will read:

DOG – RAT – RAT/M¹ - MOUSE

The instrument automatically adjusts the pulse amplifier to the appropriate sensitivity. Moreover, it modifies the parameters of electronic filter according to the size of the animal.

¹ RAT/M means a very small rat or an unusually large mouse



In fact, the respiration, the struggling and any other possible noise are linked to the size of the animal. As a rule of thumb, larger the animal, lower the frequency of the artifacts.

To supply an order of magnitude, the high-pass filter, when the dog pulse is measured, is tuned to 150 p.p.m. (pulses per minute), 300 for the rat, 450 for small rats or large mice, 600 for the mouse. Select appropriate setting for your experimental paradigm.

6.1.4 Set Reverse Pressure

During the pressure measurement, the piston starts its reverse motion when the signal is below one tenth of the starting signal. To speed up the test duration, it is possible to anticipate the piston reverse.

From the MAIN menu, depress **F1 (OPR)**, then **F2 (MOD)**, then **F4 (ESC)**. The following display will appear.

From this menu stage, by acting on the arrows, set the pressure value at which the reverse motion of the piston should start, and confirm it by the **F3 (OK)** key.

If this function is not required, depress **F4 (NUL)**.

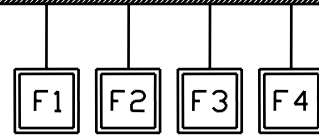
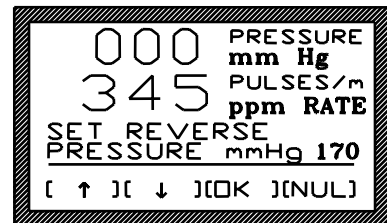

6.1.5 Set Reverse Time

If you don't select the above function and depress **F4 (NUL)** from the previous menu, the following display appears.

From this menu stage, by acting on the arrows, set the delay of the piston reverse-motion, starting from the moment when the signal reaches one tenth of the starting signal, and confirm it by the **F3 (OK)** key.

If this function is not required, depress **F4 (NUL)**.

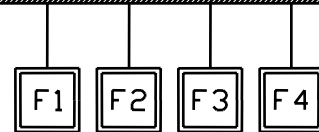
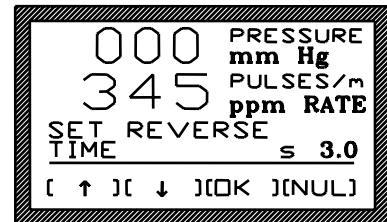

7 TEST MENU

First of all check that the cuff and the pulse transducer are properly fit to the tail of the animal.

The pressure measurement can be carried out either automatically or manually. During the automatic measurement, the instrument considers only signals which match precise parameters.

The manual measurement is useful when the signal does not match the parameters required for an automatic test and enables to see and modify the signal amplitude.

Start with the main menu and depress **F1 (OPR)**. Depress it again (**TES**).

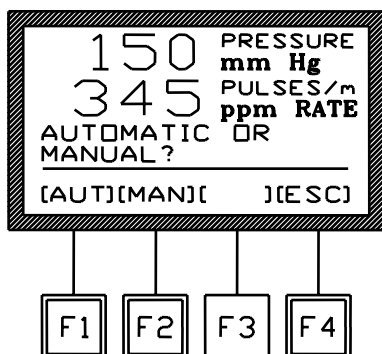

At this point, select among automatic (F1 AUT) or manual (F2 MAN) measurement.

7.1 Automatic Measurement

The instrument takes about three seconds to check the pulse amplitude, see the picture on the right.

The amplifier gain is then automatically adjusted, in order to maintain the amplitude of the graph within convenient amplitude.

In the following two seconds the average heart rate, in pulses per minute, is calculated.

If the signal is sufficient, the following display will appear: note the caption "RELIABLE SIGNAL".

Depress the blue key START/REVERSE, to begin the measuring sequence, see paragraph 7.3-Starting the Pressure Measurement.

A bar proportional to the amplitude of the signal, appears above the bottom line, to monitor the signal in real time.

In the case the signal amplitude is not sufficient, the following display will appear: note the caption "ERRATIC SIGNAL, REPEAT TEST".

Depress F4 (ESC). From the menu which appears, depress F1 (AUT) if you decide to repeat the measure automatically.

If you opt for a manual measure, depress F2 (MAN) and see paragraph 7.2-Manual Measurement. For reference

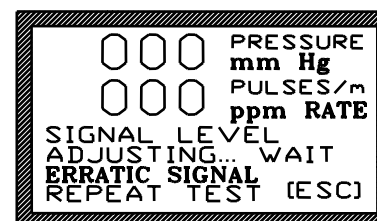
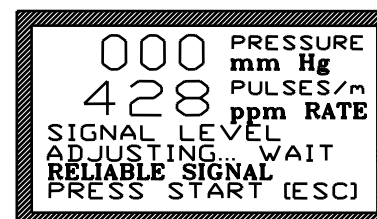
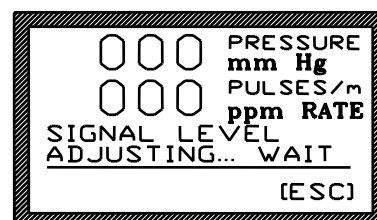

7.2 Manual Measurement

If the manual measurement has been selected, see paragraph 7-TEST MENU, the signal is displayed as one of the two following examples:

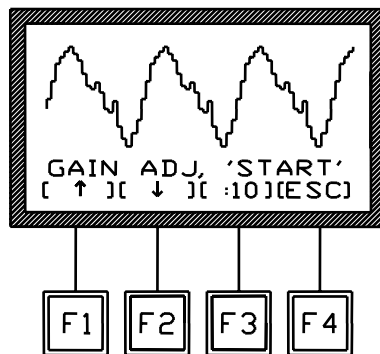
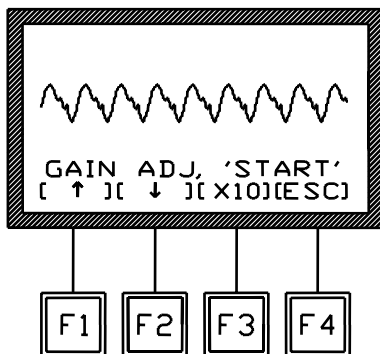

Act on the arrows keys **F1 (↑)** or **F2 (↓)** to obtain a signal within the display limits.

To obtain an optimal reading, the signal should span on all the available portion of the display.

The **F3** key, (**x10**) or (**:10**), acts as a zoom: respectively, it amplifies the display of a weak signal (see example on the left) or it makes a strong signal smaller (see example on the right).

When the signal is adjusted, depress the blue key **START/REVERSE**, see paragraph below.

7.3 Starting the Pressure Measurement

The geared motor starts at a somewhat high angular speed. But as soon the cylinder pressure reaches 10 mm Hg, the traverse speed of the piston (see paragraph 6.1.2-Speed Selection) is automatically adjusted to the selected speed (SPEED 1 or SPEED 2).

You will see from the display that the top line indicates the cuff increasing pressure, up to dated at one second intervals.

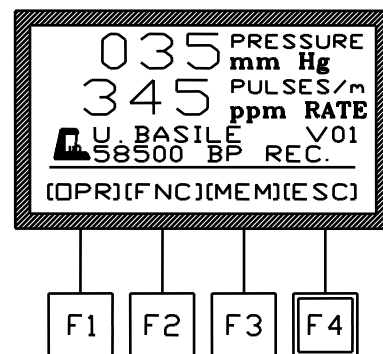

In the case the chart recorder is on and correctly set (compression phase), once the pressure reaches 50 mm Hg, the chart motion starts and the graph will appear, see the following sample of recording.

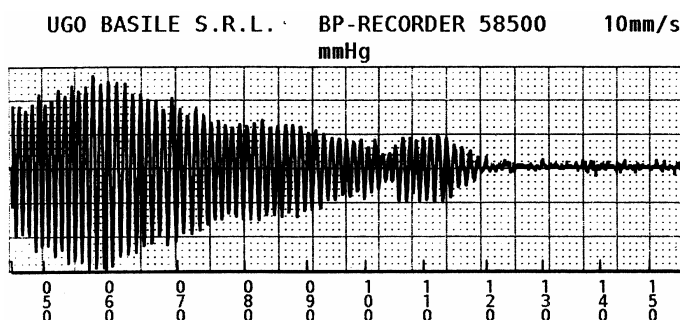

As soon the cuff pressure exceeds the systolic pressure, the amplitude of the pulse signal is reduced to nil or, better to say, in this sample which comes from a real test, to the level of *noise* (approximately 118 above). Incidentally, note that the bar we mentioned when speaking about the signal amplitude has concomitantly shrunk to a blip.

After about two seconds, the motion automatically reverses and the decompression phase begins. See the sample of graph below; note beginning of recovery of signal at approximately 114:

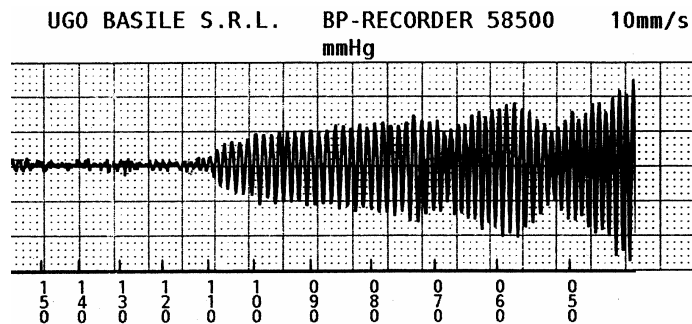

When the pressure has descended to 50 mm Hg, the chart motion stops whilst the piston continues its run until its travel end. At this point the cylinder comes in connection with the room air via a side port.

Beside the chart, even the data collection and processing stops when the pressure has descended to 50 mm Hg.

The data collection phase is over. The operator, in lieu of figures only, faces the patterns of pulse signal too, which is, by definition, the key *to read* both systolic and diastolic pressure.

If we have selected the UP/DOWN mode (systolic pressure, assessed in compression & decompression run) the following graph will appear:

The solid black zones are *tight packages of spikes*. Each spike represents a pulse beat generated by the caudal artery (arteria caudalis) and transmitted via the surrounding tissues to the pulse transducer.

In the top line we read **SYST.UP** and the pressure value (141 mm Hg in this example) at which the pulse amplitudes is reduced to nil.

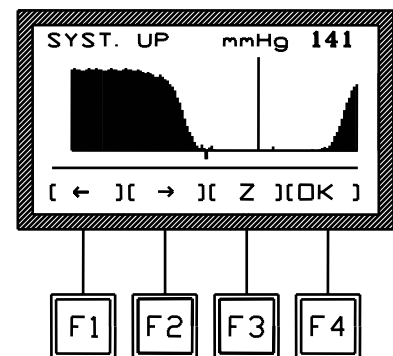

The vertical line represents the division between the compression and decompression phases. The cursor, the small mark at the centre of the graph, can be shifted back and forth via **F1** and **F2**. When the cursor moves, the corresponding pressure value (141 in this example) changes accordingly.

By shifting the cursor, the trained operator can select in the graph the point at which the pulse disappears (**systolic**) and the point at which there is an unmistakable transition from steady to decreasing amplitude (**diastolic**) **even in unfavourable trials**.

It is plain to see, when accidental *noise*, in practice brought about by animal struggling, spoils the clarity of the graph outline, i.e., spurious “spikes” appear amid the smooth pressure outline.

The key **F3 (Z)** helps to increase the size of the graph acting as a zoom. By depressing **F3** again the graph returns to the original size. At this point, depress the key **F4 (OK)** and the following display will appear:

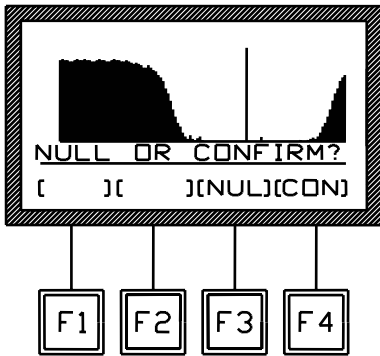

The datum (in our case the systolic pressure) can be saved by the **F4 (CON)** key or cancelled by the **F3 (NUL)** key as shown in the display at this side.

In either case, the display shows the following picture, which illustrates the diastolic pressure pattern (if previously set).

The cursor mark is over the graph and the pressure figure is below the base line.

As in the previous case, the cursor can be shifted to select the best possible position.

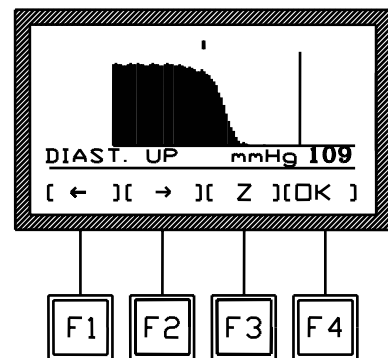

In the case the Chart Recorder is on, the final picture of the experiment is recorded (see the example taken from a real experiment) where we read, from the top of the data set:

- ⇒ date
- ⇒ time
- ⇒ systolic pressure (compression run)
- ⇒ diastolic pressure (compression run)
- ⇒ systolic pressure (decompression run)
- ⇒ diastolic pressure (decompression run)
- ⇒ pulse rate
- ⇒ gender
- ⇒ animal number

```

2003/02/05
15:25:13
Systolic Up      121
Diastolic Up     070
Systolic Down   116
Diastolic Down   072
Pulse Rate      545
Gender Male
Animal N° 12

```

The latter two data, gender and animal number, are represented in the display as, e.g., M1 which means animal No. 1, male, F3 which means animal No. 3, female, etc.

8 CALIBRATION

To calibrate means to compare the pressure reading of 58500 with the data supplied by a precision mercury pressure gauge (or any other certified pressure standard) capable to cover the range 50 – 300 mm Hg.



It is advisable to calibrate the instrument at monthly intervals, in particular when it works daily.

Connect the pneumatic outlet (the outlet to which you connect the cuff) to the standard pressure gauge.

From the main menu, press **F1 (OPR)** key, followed by the **F3 (CAL)** key. A display like this will appear.

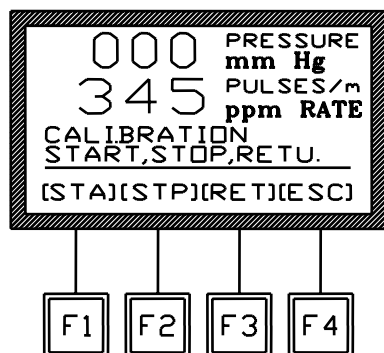

Start the calibration by depressing **F1 (STA)**. You may follow the pressure build-up on the display but it is more convenient to watch the mercury column or the hand of the precision standard manometer.

Stop the pressure build-up by depressing **F2 (STP)** at an intermediate value, say, at 100 mm Hg. Wait at least 10 seconds in order to stabilize the air motion in the piping, cylinder and expansion vessel, plus the mercury oscillations (in case a mercury gauge is used).

As soon **F2 (STP)** is depressed, this display will appear.

In case of discrepancy between display and actual pressure, correct the value by adjusting display as follows: press **F1 (↑)** to increase the value you read on the display or **F2 (↓)** to decrease it, until the two figures (display and actual pressure) match.

When this has been attained, press **F3 (OK)** to accept value and conclude calibration.

If you want to interrupt this procedure, press **F4 (NUL)** to reset the system to the previous configuration.

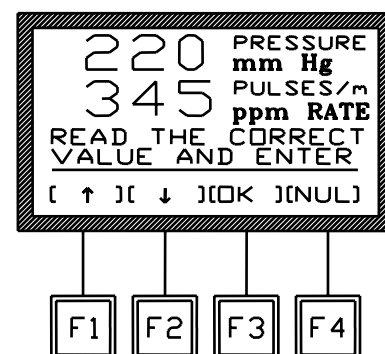

9 DATA PRINT-OUT AND OUTPUT TO THE PC

9.1 How to Set the Data Output

If no path is set, the acquired data are saved in the BP Recorder internal memory only: during the experimental trial, the data can also be printed out in real time on the Chart Recorder, or routed to the PC for real time or remote communication.



To print the graph and the digital data on the Chart Recorder, from the main menu press **F2 (FNC)** key, followed by the **F1 (OUT)** key.

Press the **F1 (PAT)** key again; a display like the one shown here will appear.

Select now the **F1 (PRN)** key to enable the data **print-out in real time**.

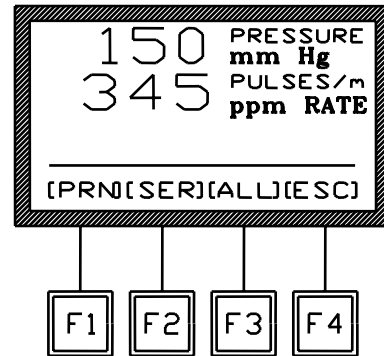

The **F2 (SER)** key allows direct **connection to the PC** for exporting the experimental data in real time or in remote conditions.

Serial communication between our BP Recorder and the PC is facilitated by our Win-DAS software, see paragraph 3-DATA ACQUISITION.

The **F3 (ALL)** key enables the researcher to select **both output paths** (to Printer and to PC) simultaneously.

In the case that the operator wants to **cancel one of the previously activated choices** (PRN, SER or ALL), it is necessary to enter the **PATH** menu and press the **F4 (ESC)** key, selecting no option.

9.2 Instrument Address and Baud-Rate

When the SER or ALL functions are activated, and the 585600 is correctly connected to the PC, the message **"CONNECTED TO PC"** appears on the display.

From this menu the operator can set via the **F1 (ADD)** key the address of the instrument which is routing data to the PC and the communication speed (baud-rate).

The default **address** is **01** and the default **baud-rate** is **300**.

The factory set parameters are normally suitable; in this case the operator can clear this menu by pressing the **F4 (ESC)** key.

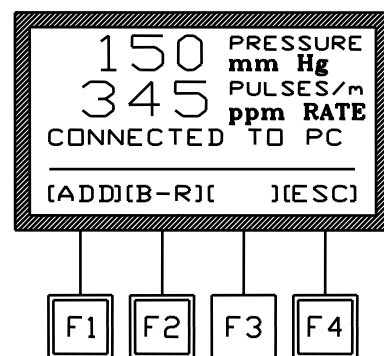

To modify the **address**, if necessary, press the **F1 (ADD)** key; select by the up or down arrows the desired address (**from 01 to 99**) and then depress the **F4 (ESC)** key.

To change the factory set baud-rate, depress the **F2 (B-R)** key. Select the desired value by the arrows in the loop which includes **300 – 600 – 1200 – 2400 – 4800 BPS**. Then depress the **F4 (ESC)** key.

The baud-rate must be identical to the value set on the Win-DAS software (see 52010 manual).



9.3 How to Set a Customized Experimental Configuration

From the main menu, press the **F2 (FNC)** key, followed by the **F1 (OUT)** key. Depress the key **F2 (FTR)** again; the display shows:-

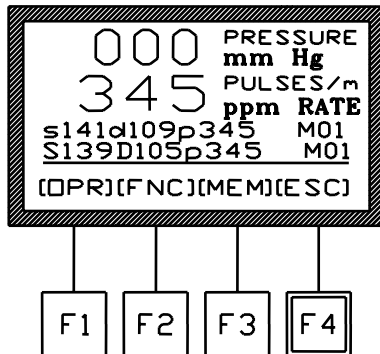

This function enables the operator to personalize basic input data, by adding:

- sequence number (see paragraph 9.3.1)
- gender of the animal (see paragraph 9.3.2)

All the available selections for each additional information are displayed in a loop, on the right side of the middle level of the graphic display.

Scroll through them by the **F1 (↑)** or **F2 (↓)** keys, select the parameter and confirm the selection by pressing the **F3 (OK)** key. To avoid one or more features, press the **F4 (NUL)** key.

By pressing and releasing the arrow keys, the numerical value will increase or decrease of one step. By keeping them pressed longer, the selection can be made at higher speed.

The selected features will be kept in the instrument's memory even when it is turned off.

To erase one or more parameters previously set, simply enter this software level, highlight the concerned feature and depress the F4 (NUL) key.

After entering the last parameter (M or F), the software automatically returns to the main menu.

9.3.1 Sequence Number

The first additional parameter to be defined is the sequence number (or trial number). This section is highlighted as soon as the **F2 (FTR)** key is depressed. Use the **F1 (↑)** or **F2 (↓)** keys to set the desired sequence number **from 01 to 99** and confirm it by depressing the **F3 (OK)** key.

The sequence number will automatically increase by one, upon any subsequent measurement.

It advances once a trial has been acquired and recorded, indicating the fresh sequence number ready for the next measurement.

If a sequence number is not necessary, depress the **F4 (NUL)** key:

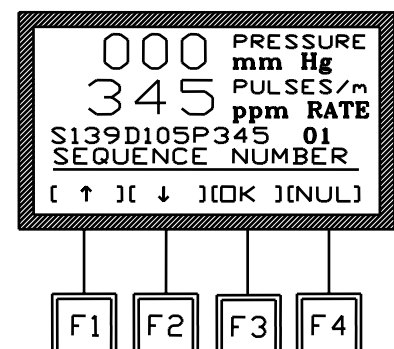



IMPORTANT:

When a fresh experimental session begins, the sequence number can commence from the last number reached at the end of the previous trial, otherwise, a fresh number can be entered, following the instructions outlined above, for example starting from 01.

9.3.2 *Animal Gender*

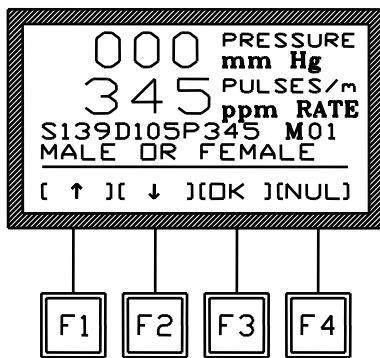

After the sequence number, it is possible to indicate the sex of the animal which is to be tested.

Select this parameter by pressing the **F1 (↑)** or **F2 (↓)** keys and confirm it via the **F3 (OK)** key.

The user can choose not to input this parameter by pressing the **F4 (NUL)** key.

10 QUICK SETTING OF THE BP RECORDER

This Instruction Manual explains extensively how to take advantage of all the features offered by this microprocessor-controlled unit.

The following table summarizes features; however, we strongly recommend you to read the complete manual to learn details of functions.

IMPORTANT: all sequences of commands is described starting from the **MAIN MENU**.

Command Description	Command Sequence	Paragraph reference
Set pressure measurement features without automatic reverse piston	(OPR) – (MOD) – (MEA) – (ESC) – (NUL) – (NUL)	6.1.1
Set pressure increasing rate & chart speed without automatic reverse piston	(OPR) – (MOD) – (SPE) – (ESC) – (NUL) – (NUL)	6.1.2
Set animal number without automatic reverse piston	(OPR) – (MOD) – (ANI) – (ESC) – (NUL) – (NUL)	6.1.3
Set reverse pressure	(OPR) – (MOD) – (ESC) – (↓/↑) – (OK)	6.1.4
Set reverse time	(OPR) – (MOD) – (ESC) – (NUL) – (↓/↑) – (OK)	6.1.5
Set calibration	(OPR) – (CAL) – (STA) – (STP) – (↓/↑) – (OK)	8



Command Description	Command Sequence	Paragraph reference
Start automatic blood pressure measurement	(OPR) – (TES) – (AUT) - blue key START/ REVERSE	7.1
Start manual blood pressure measurement	(OPR) – (TES) – (MAN) - blue key START/ REVERSE	7.2
Turn chart recorder on	(FNC) – (OUT) – (PAT) – (PRN)	9.1
Print data , previously saved in the internal memory	(MEM) – (OUT) – (YES/NO) – (PRN)	11
Send to PC (data previously saved in the internal memory)	(MEM) – (OUT) – (YES/NO) – (SER)	11
Set TIME	(FNC) – (CLK) – (TIM) – (↓/↑) – (ENT)	11.2
Set DATE	(FNC) – (CLK) – (DAT) – (↓/↑) – (ENT)	11.2
Set DISPLAY CONTRAST	(FNC) – (DIS)– (↓/↑) – (ESC) – (ESC)	11.3

While the experiment is in progress, if properly set via the **F4** key from the Main Menu, the display shows all incoming data in real time.

11 MEMORY MANAGEMENT

Each trial, no matter whether printed or sent to the PC, is saved in the memory, which can store about 300 strings, including the result of the trial and the date/time indication.

By pressing the **F3 (MEM)** key from the main menu, the **MEMORY** Menu can be reached.

The **F1 (VW)** key enables the operator to view the data stored in the memory, each datum complete with acquisition Date & Time.

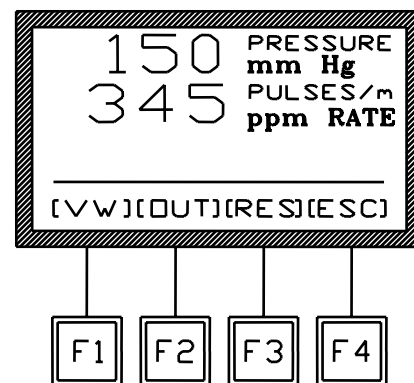
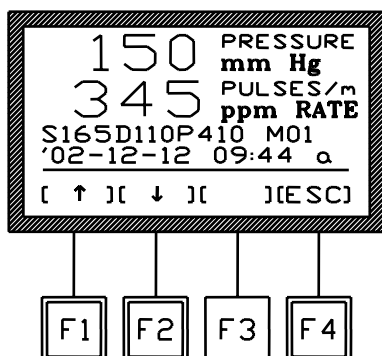

Use the vertical-arrow keys **F1 (↑)** or **F2 (↓)** to scroll the data; by momentarily depressing the key, the trial displayed will increase (or decrease) of one measurement. Scan the data at higher speed by holding these keys down longer.

As usual the **F4 (ESC)** recalls the previous menu software or abandons an erroneous selection.

From the **MEMORY** Menu, the **F2 (OUT)** key enables the researcher to export the data stored in the memory to the PC, or to print the data.



Before selecting the output, the operator will be asked if he/she is interested to tag each datum with the related Date & time, by answering **(YES)** (**F3** key) or **(NO)** (**F4**) to the question "WITH DATE & TIME?"

If the researcher selects the combined printing, time and date will appear on the second line.

The researcher can now select the data output path (see paragraph 9.1-How to Set the Data Output).

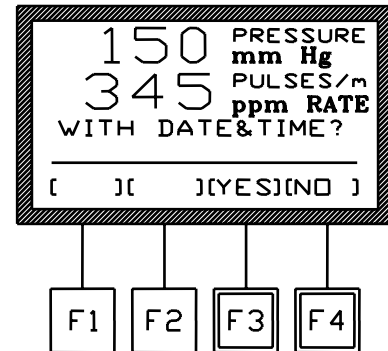

See the following example of a print:

<pre> Data LIST in memory S161D073p133 gMa01 2003/09/05 09:11:07 S161D071p133 gMa02 2003/09/05 09:19:22 s171d078p133 gMa03 2003/09/05 09:25:13 S163D070p133 gMa03 2003/09/05 09:27:58 s169d077p133 gMa04 2003/09/05 09:32:18 S161D070p133 gMa04 2003/09/05 09:36:12 </pre>	<p>← Capital S and D mean systolic and diastolic in decompression phase</p> <p>← Small s and d mean systolic and diastolic in compression phase</p>
--	---

To interrupt the print-out response of the stored Data, hold down the **F4 (ESC)** key for at least one second.

Before starting a new experimental session, we suggest to check the memory, which may contain previously stored data. If it is the case, enter the proper software level and reset the memory.

11.1 Memory Reset

From the Memory menu, the F3 key (**RES**) enables the operator to reset the data stored in the memory.

This command can be useful, for instance, if the operator prefers to dump data from previous experiments, before starting a new experimental session.



The operator is now required to answer **(YES)** (**F3** key) or **(NO)** (**F4** key) to the question: “are you sure?”. This confirmation has been added to avoid the accidental loss of all stored data.

The Memory menu automatically appears also when the memory cache is full, which means it has reached its maximum capability of about 300 lines.

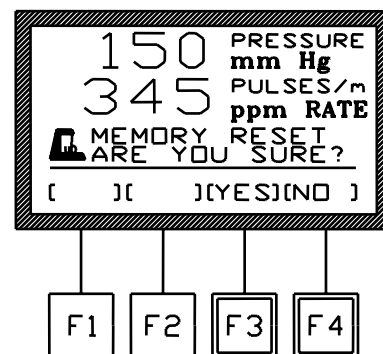

11.1.1 “Memory Full” Message

If the “**MEMORY FULL**” message appears during acquisition, the operator has three options:-

- 1) the researcher who is not interested in considering the data saved in the memory, may simply depress the **F3 (RES)** key and confirm the reset by answering **F3 (YES)** to the question “ARE YOU SURE?”, see paragraph 11.1.
- 2) in the case the data previously saved in the memory are required, print and/or send them to the PC as previously explained (see paragraph 11-MEMORY MANAGEMENT).
- 3) you may also ignore the indication of “MEMORY FULL” and go on with the experiment by depressing the **F4 (ESC)** key. The data acquired onwards will not be saved. Consider that, in this case, the memory remains fully loaded and the display reminds it by showing the message “MEMORY FULL” each time the instrument is switched ON.

11.2 Setting Time & Date

To set time and date, from the Main menu press the **F2 (FNC)** key, followed again by the **F2 (CLK)** key.

Select **F1 (TIM)** to set TIME. Use the **F3** horizontal arrow key to highlight, on the intermediate level of the display, the time section (hours, minutes, seconds and mode) which has to be modified.

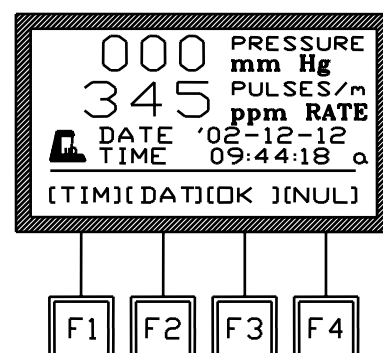

Now use the vertical-arrow keys **F1 (↑)** or **F2 (↓)** to set the correct time; a momentarily action on the keys will increase or decrease the numerical value of one step: press the keys longer for higher speed selection.

Also remember to set the **clock mode**, selecting among the following possibilities:-

- 00 = 24-hour mode**
- 01 = anti-meridian (a.m.) time**

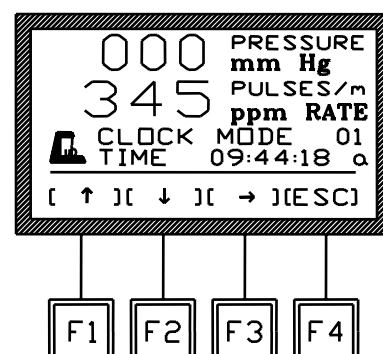



02 = post-meridian (p.m.) time

Once the **TIME** setting is complete, press the **F4 (ENT)** key to save the setting and go back to the Main Menu.

Follow the same procedure to set the **DATE**, selecting now the **F3 (DAT)** key. Enter also the **DAY OF THE WEEK**, referring to the following table:-

- 01 = Monday
- 02 = Tuesday
- 03 = Wednesday
- 04 = Thursday
- 05 = Friday
- 06 = Saturday
- 07 = Sunday

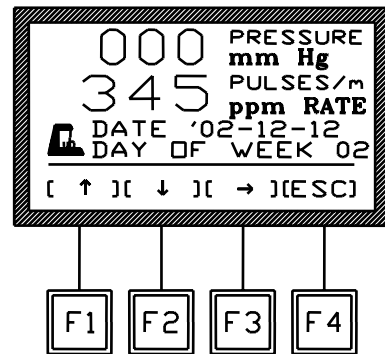

Press the **F4 (ENT)** key to confirm the selection.

11.3 Display Contrast

To modify the display contrast, press the **F2 (FNC)** key from the Main Menu, then the **F3 (DIS)** key. The display shows:

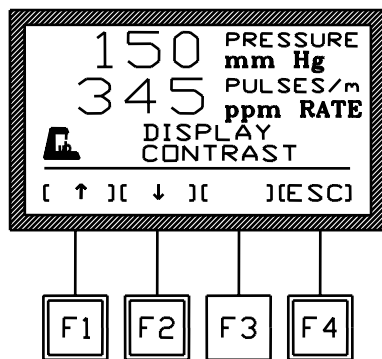

Keep the arrow keys **F1 (↑)** or **F2 (↓)** pressed until you reach the desired display contrast.

The readability of the liquid crystal display depends on the angle of view: select the ideal contrast according to the height of the table, the operator's distance and so on.

Note that the display brightness can slightly change, during the operation, due to variation of the instrument temperature. Adjust it, if necessary.

Leave this software level, saving the selected display contrast, by pressing the **F4 (ESC)** key.

12 MAINTENANCE

While any service of the instrument is to be carried out by Ugo Basile personnel or by qualified personnel, authorized by UGO BASILE organization, this section of the instruction manuals describes normal maintenance procedures which can be carried out at the customer's facilities.

UNPLUG THE MAINS CORD BEFORE CARRYING OUT ANY MAINTENANCE JOB!



12.1 Electrical

To inspect and/or replace the fuses, **disconnect the mains cable first!** Insert a miniature screwdriver in the slot indentation, see paragraph 4.3-Fuse Holder & Voltage Selector, and snap out the slide which houses the fuses.

For operation at 230-240 Volts, we recommend 315 mA timed fuses (type T315). Use 630 mA fuses (type T630) for operation at 115 Volts.

Having extracted the fuse slide, the Voltage selector becomes accessible. The same miniature screwdriver will help you to pry out the cross jumper on which the operation voltage is engraved. Place the jumper upside down if you have to shift from 115 to 230V or vice versa.

Snap in the fuse slide: the mechanical “*click*” ensures that it is locked. Check the voltage flag visible in the window, before applying electrical power.

12.2 Replacing a Leaky Pressure Cuff Membrane

Take out the leaky membrane. Fit the fresh membrane into the cuff tube and fold back its edges. When you have completed the job, ensure that the membrane is not twisted, as this may produce wrinkles.

Use the Perspex O-Ring fitter provided to affix the two O-Rings. Roll up the O-Rings along the cone, until they reach the cylindrical section: insert the conical side of the fitter into the cuff and transfer the O-Rings over the folds of the membrane until they are seated into the ring grooves, see Figure 5 “Tail Cuff”.

12.3 Replacing the Paper Roll

When the printer is out of paper, the display shows the following warning message.

Insert a fresh roll, paying attention to its orientation; Figure 11 “Paper Roll” is self-explanatory on what concerns the replacement.

See paragraph 13.4-Accessories and Consumables, for catalogue number of paper rolls.

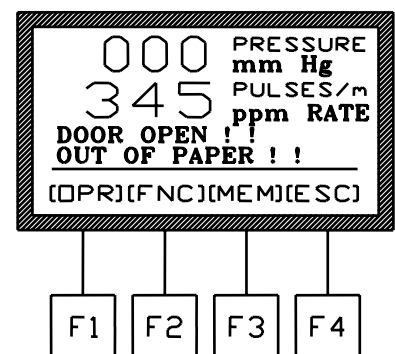

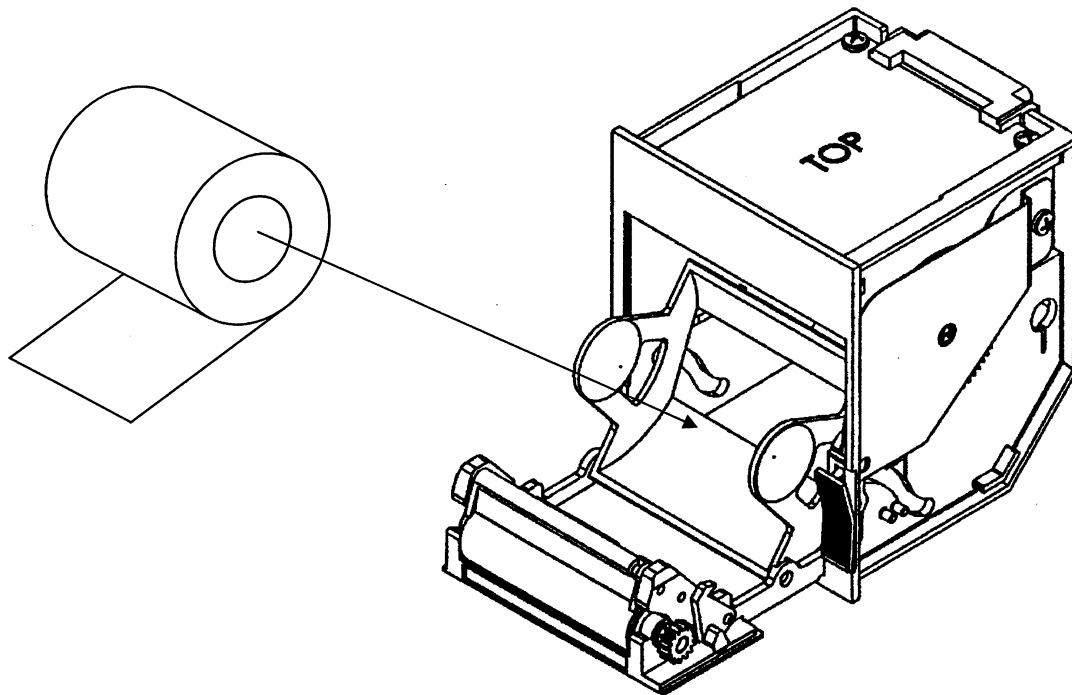

Figure 11 "Paper Roll"

12.4 Long Inactivity

The instrument does not require any particular maintenance after long inactivity, except cleaning.

Check the consistency of rubber membranes and O-rings and replace them, if necessary. Remember that both should be stored away from daylight which in the long run degrades their consistency.

Calibrate instrument before using, see paragraph 8-CALIBRATION.

12.5 Customer Support

For any further information you may desire concerning the operation and/or maintenance of the BP Recorder, please do not hesitate to get in touch with our local distributor or with our **service department** at:-



UGO BASILE S.r.l.
Via Guido Borghi 43
21025 COMERIO – Varese, ITALY



Phone : +39 0332 744574



Fax : +39 0332 745488



e-mail : service@ugobasile.com



Before sending any instrument to our factory for repair, we recommend you to get in touch with our service department (mentioning the serial number of your instrument) to obtain a return authorization number (R.A.N.) and shipping instructions.

We may not be held responsible for damages of returned instruments during transport due to poor packing. Whenever possible, please use the original packing.

13 ORDERING INFORMATION

58500 BP RECORDER FOR RAT, provided with graphic printer, graphic display, serial port RS232C and analog output to Digital Recorder (PowerLab or similar). Complete with accessories for Rat (8 mm pulse pick-up, 13 mm pressure cuff and 50 mm rat holder)

58600 BP RECORDER FOR MOUSE, as above, but complete with accessories for Mouse (3 mm pulse pick-up, 6 mm pressure cuff and mouse holder)

58700 BP RECORDER FOR DOG, as above, but complete with accessories for Dog (18 mm pulse pick-up and 20 mm pressure cuff)

All models are complete with following standard accessories :-

58000-301 Dust Cover

58000-302 Instruction Manual

58500-305 Package of 10 Heat-Sensitive Paper Rolls (2 rolls are provided as standard)

52050-08 CUB Dedicated Data Acquisition Software, for direct connection to PC serial or USB port (cable & adaptor included)

52010-320 USB Converter to serial port

52010-322 Connecting cable 9 to 9 PIN

E-WP008 Mains Cable

Set of 2 fuses for either 115 VAC or 230 VAC mains

13.1 Available Pulse Pick-ups

58000-503 Pulse Pick-up for Mouse, diam. 3 mm

58000-504 Pulse Pick-up for Mouse, diam. 4 mm

58000-505 Pulse Pick-up for Rat, diam. 5 mm

58000-506 Pulse Pick-up for Rat, diam. 6 mm

58000-507 Pulse Pick-up for Rat, diam. 7 mm

58000-508 Pulse Pick-up for Rat, diam. 8 mm

58000-509 Pulse Pick-up for Rat, diam. 9 mm

58000-518 Pulse Pick-up for Dog, diam. 18 mm



13.2 Available Tail Cuffs

- 58000-606 Tail Cuff for Mouse, diam. 6 mm
- 58000-609 Tail Cuff for Rat, diam. 9 mm
- 58000-613 Tail Cuff for Rat, diam. 13 mm
- 58000-620 Tail Cuff for Dog, diam. 20 mm
- 58000-624 Tail Cuff for Dog, diam. 24 mm

13.3 Available Holders

- 58000-343 Mouse Holder
- 58000-344 Rat Holder, 40 mm I.D.
- 58000-345 Rat Holder, 50 mm I.D.
- 58000-346 Rat Holder, 60 mm I.D.

13.4 Accessories and Consumables

- 58000-320 Foam Ring for all pulse Pick-ups (set of 3)
- 58000-706 Set of 5 Membranes for 6 mm Cuff
- 58000-709 Set of 5 Membranes for 9 mm Cuff
- 58000-713 Set of 5 Membranes for 13 mm Cuff
- 58000-720 Set of 5 Membranes for 20 mm Cuff
- 58000-724 Set of 5 Membranes for 24 mm Cuff
- 58000-806 Set of 2 O-Rings for 6 mm Cuff
- 58000-809 Set of 2 O-Rings for 9 mm Cuff
- 58000-813 Set of 2 O-Rings for 13 mm Cuff
- 58000-820 Set of 2 O-Rings for 20 mm Cuff
- 58000-824 Set of 2 O-Rings for 24 mm Cuff
- 58000-906 O-Ring Fitter for 6 mm membrane
- 58000-909 O-Ring Fitter for 9 mm membrane
- 58000-913 O-Ring Fitter for 13 mm membrane
- 58000-920 O-Ring Fitter for 20 mm membrane
- 58000-924 O-Ring Fitter for 24 mm membrane

13.5 Optional

- 58000-350 Rat Simulator
- 58000-351 Spare Rubber Tail for Rat Simulator
- 58000-840 Mouse Heater, complete with 6 mouse holders.



58000-845 Rat Heater, complete with 5 rat holders of selectable I.D.²

58000-850 Rat Scanner, complete with 5 rat holders of selectable I.D.²

NOTE Pressure cuffs & pulse pick-ups are not included and are to be purchased separately

13.6 Specifications

Start-Stop	:	via the START key on the front panel
Pressure Range	:	50 to 290 mm Hg
Power Requirements	:	115 or 230 V, 50/60 Hz, 25 W max.
Operating Temperature	:	0° to 40° C
Sound Level	:	< 70 dB
Weight (net)	:	Kg 10.6
Shipping Weight	:	Kg 15.0 approx.
Dimensions	:	35 x 35 x 16.5 (h) cm
Packing dimensions	:	67 x 42 x 53 cm

14 BIBLIOGRAPHY

- M. Gerold & H. Tschirky “**Measurement of Blood Pressure in Unanaesthetized Rats**” Arzneimittelforschung 18: 1285-287, 1968
- M. Gerold & H. Fünfshilling: “**Abhängigkeit der Indirekten Blutdruckmessung an Ratten von der Grösse der Kompressionmanchetten**” Arzneimittelforschung. 21: 2071-2074, 1971.

² If no other diameter is specified, we will supply the 50mm size



WIRING DIAGRAMS

58000-001ES01 (sh 1 of 4)	Wiring Diagram
58000-001ES01 (sh 2 of 4)	Wiring Diagram
58000-001ES01 (sh 3 of 4)	Wiring Diagram
58000-001ES01 (sh 4 of 4)	Wiring Diagram
58000-001EL01 (sh 1 of 5)	Electronic List
58000-001EL01 (sh 2 of 5)	Electronic List
58000-001EL01 (sh 3 of 5)	Electronic List
58000-001EL01 (sh 4 of 5)	Electronic List
58000-001EL01 (sh 5 of 5)	Electronic List
58000-001EC01	Board Component Layout
58000-001 ES02	Wiring Diagram
58000-001 EL02	Electronic List
58000-001 EC02	Board Component Layout
58000-001 EW01	Cables & Connectors
58000-001 EA01	Interconnection Diagram
58000-001EX01 (sh 1 of 2)	Electronic List, External Components
58000-001EX01 (sh 2 of 2)	Electronic List, External Components
58500-001EX01	Electronic List, External Components
58000-001 EF02	Function Key Block Diagram

WIRING DIAGRAMS ARE NOT INCLUDED IN THE MANUAL, BUT ARE AVAILABLE ON REQUEST.

PLEASE ADDRESS TO OUR AFTER SALES SERVICE, SEE ALSO PARAGRAPH **12.5-Customer Support**

Notes

A series of horizontal dashed lines for writing notes.

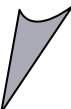



ugo basile®

TRANSFORMING IDEAS
INTO INSTRUMENTS

CE CONFORMITY STATEMENT

Manufacturer **UGO BASILE srl**
Address Via G. di Vittorio, 2 – 21036 Gemonio, VA, ITALY
Phone n. +39 0332 744574
Fax n. +39 0332 745488

We hereby declare that

Instrument. **BLOOD PRESSURE RECORDER RAT/MOUSE**
Catalog number **58500 – 58600 - 58550**

*is manufactured in compliance with the following European Union Directives
and relevant harmonized standards*

- *2006/42/CE on machinery*
- *2014/35/UE relating to electrical equipment designed for use within certain voltage limits*
- *2014/30/UE relating to electromagnetic compatibility*
- *2011/65/UE and 2015/863/UE on the restriction of the use of certain hazardous substances in electrical and electronic equipment*

Account Manager

Mauro Uboldi

Nome / Name

October 2018

Date

Firma / Signature