

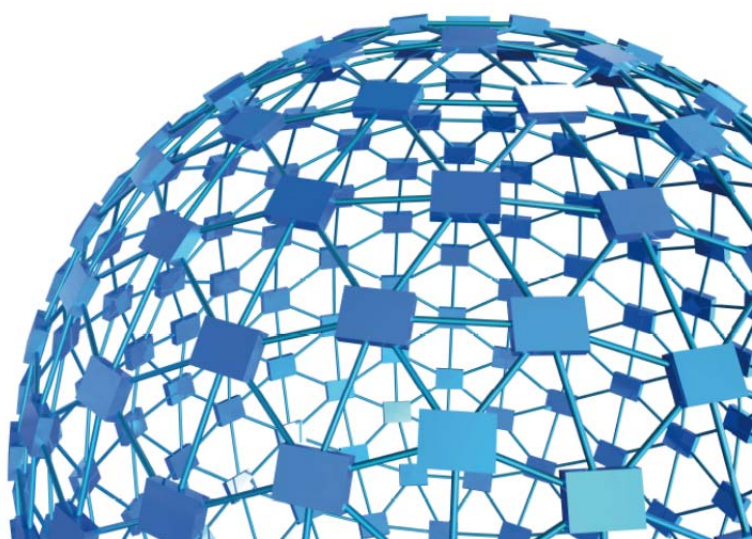

ugo basile®

instruction manual

ORO - Orofacial Stimulation Test
Cat. No. 31300



UGO BASILE S.R.L.

sales@ugobasile.com / service@ugobasile.com www.ugobasile.com

UGO BASILE S.R.L.

Via G. Di Vittorio, 2
21036 GEMONIO, VA, ITALY
Phone: +39 0332 744574

sales@ugobasile.com / service@ugobasile.com
www.ugobasile.com

instruction manual

Orofacial Stimulation Test
Cat. No. 31300

Serial No.

SAFETY CONSIDERATIONS

ALTHOUGH THIS INSTRUMENT HAS BEEN DESIGNED WITH INTERNATIONAL SAFETY STANDARD, THIS MANUAL CONTAINS INFORMATION, CAUTIONS AND WARNINGS WHICH MUST BE FOLLOWED TO ENSURE SAFE OPERATION AND TO RETAIN THE INSTRUMENT IN SAFE CONDITIONS.

SERVICE AND ADJUSTMENTS SHOULD BE CARRIED OUT BY QUALIFIED PERSONNEL, AUTHORIZED BY UGO BASILE ORGANIZATION.

ANY ADJUSTMENT, MAINTENANCE AND REPAIR OF THE OPENED INSTRUMENT UNDER VOLTAGE SHOULD BE AVOIDED AS MUCH AS POSSIBLE AND, WHEN INEVITABLE, SHOULD BE CARRIED OUT BY A SKILLED PERSON WHO IS AWARE OF THE HAZARD INVOLVED.

CAPACITORS INSIDE THE INSTRUMENT MAY STILL BE CHARGED EVEN IF THE INSTRUMENT HAS BEEN DISCONNECTED FROM ITS SOURCE OF SUPPLY.

Orofacial Stimulation Test

Fehrenbacher, Henry and Hargreaves Method

Cat. No. 31300

Mechanical Nociception

Thermal Nociception

Trigeminal
hyperalgesia

General

The **Orofacial Stimulation Test** by **Ugo Basile** measures hypersensitivity to thermal or mechanical stimulation of the trigeminal area.

Rats voluntarily contact a thermal or a mechanical stimulator with their *unshaved vibrissal pad* in order to access a food reward. Metrics obtained are the **duration** of feeding and the **number of feeding** attempts, measured by interruption of an infrared barrier traversing the opening to the reward.

Feeding duration and number of attempts are strongly dependent on changes in the applied thermal or mechanical stimulus.



Main Features

- Mechanical and thermal nociception assays within the same experiment
- High throughput: up to 16 animals can be tested simultaneously
- Intact vibrissal pad, as the test does not require any shaving
- The ORO-Software, included as standard, manages up to 16 cages

Ugo Basile: more than 10,000 citations



CHECK-LIST OROFACIAL STIMULATION TEST

Cat. No. 31300 One Cage Set-Up
 Cat. No. 31320 Two Cage Set-Up
 Cat. No. 31340 Four Cage Set-Up

CLIENTE / CUSTOMER _____

Ordine No. / Order No. _____ Data / Date ____/____/____

UB code	CAT.No.	√	31300	31320	31340	DESCRIPTION
	31300-001		1	1	1	ELECTRONIC UNIT
	31300-002		1	2	4	OROFACIAL STIMULATION WALL, COMPLETE
	31300-320		0	1	1	WARM-WATER DISTRIBUTOR
	31300-003		1	1	1	HEATING/CIRCULATING BATH
E-AU 041 USB pen-drive	31300-010		1	1	1	"ORO" SOFTWARE
	52010-323		1	1	1	USB CABLE
E-AU 059			1	1	1	UNIVERSAL POWER SUPPLY
E-WP 008			1	1	1	MAINS CORD
E-WP 008-01			1	1	1	
M-CM 458-F-1			1	2	4	PEDAL SWITCH
OPTIONAL:						
	31300-323		1	2	4	OPTIONAL MOUSE ADAPTOR KIT

DATE / /	Serial No.	IMBALLATO DA / PACKED BY
Universal Input 85-264 VAC, 50-60Hz		

IMPORTANT/IMPORTANTE:

Check the shipment for completeness immediately after receipt: should you find any discrepancy, please fill in the following part and transmit it to our fax no. +39 0332 745488

Al ricevimento della merce controllate che la spedizione sia completa: in caso di discrepanza, completate il formulario di seguito riportato ed inviatelo al nostro fax no. 0332 745488

FROM: Name	Company/Institution
DATE	REF.

NOTE

CONTENTS

1	GENERAL	1
1.1	PRINCIPLE OF OPERATION	1
2	INSTRUMENT DESCRIPTION	2
2.1	SYSTEM COMPONENTS	3
2.2	CAGE ASSEMBLY AND STIMULATION “WALLS”	3
2.2.1	OPTIONAL MOUSE ADAPTOR KIT	4
2.3	ORO-SOFTWARE	4
3	INSTALLATION	5
3.1	UNPACKING & PRELIMINARY CHECK	5
3.2	NOTES ON THE INSTRUCTION MANUAL	6
3.3	RECOMMENDED OPERATING CONDITION	6
3.4	SETTING-UP A BASIC SYSTEM	6
3.4.1	ASSEMBLING THE STIMULATION WALL	7
3.4.2	HYDRAULIC CONNECTIONS	9
3.4.3	MOUSE ADAPTOR	10
3.4.4	ELECTRICAL CONNECTIONS	11
3.4.5	INSTALLING THE ORO SOFTWARE	11
3.5	INTENDED USE	11
3.6	GENERAL SAFETY INSTRUCTIONS	11
3.7	ADDITIONAL SAFETY CONSIDERATION	12
4	OPERATION	12
4.1	SWITCHING-ON	12
4.2	TESTING THE ANIMAL	13
4.3	CALIBRATION	13
5	MAINTENANCE	14
5.1	CLEANING AND STERILIZATION	14
5.2	DISPOSAL OF OLD ELECTRICAL & ELECTRONIC EQUIPMENT	14
5.3	ABNORMAL CONDITIONS	15
5.4	LONG INACTIVITY	15
5.5	CUSTOMER SUPPORT	15
6	ORDERING INFORMATION	15
6.1	OPTIONAL	16
7	INSTRUMENT SPECIFICATIONS	16

8	BIBLIOGRAPHY	17
---	---------------------------	----

FIGURE INDEX

<i>Figure 1</i>	<i>“Orofacial Stimulation Set-Up”</i>	2
<i>Figure 2</i>	<i>“Thermal Stimulator”</i>	3
<i>Figure 3</i>	<i>“Mechanical Stimulator”</i>	4
<i>Figure 4</i>	<i>“Mouse Adaptors”</i>	4
<i>Figure 5</i>	<i>“Orofacial Software: testing window”</i>	5
<i>Figure 6</i>	<i>“Wall Components”</i>	7
<i>Figure 7</i>	<i>“Assembling the stimulator on the wall”</i>	8
<i>Figure 8</i>	<i>“Positioning the Drinking Bottle”</i>	9

Orofacial Stimulation Test

Cat. 3 1 3 0 0

1 GENERAL

“Orofacial pain is a frequent form of pain perceived in the face and/or oral cavity. It may be caused by diseases or disorders of regional structures, dysfunction of the nervous system, or through referral from distant sources” (William Maixner, DDS PhD, chair of the IASP 2014 Global Year Against Orofacial Pain).

Orofacial pain problems are common and involve structures and mechanisms unique to the trigeminal nerve.

Few methods are currently available for orofacial preclinical research, and none incorporates parallel measurement of mechanical or thermal stimulation within the same experiment.

Moreover, while most of the current assays measure unlearned behaviors, such as flinching or withdrawal reflexes, this new **Orofacial Stimulation Test** integrates higher order brain functions into measurements of orofacial nociception.

This innovative approach permits highly integrated nociceptive responses to thermal or mechanical stimulation.

1.1 Principle of Operation

The **“System and Method for Assessing Hypersensitivity to Orofacial, Thermal and Mechanical Stimulation”** (US Provis. Patent Application 61/235,590) was invented by J. Fehrenbacher, M. Henry & K. Hargreaves, in the Laboratory of Dr. Hargreaves at UT San Antonio (see paragraph 8-BIBLIOGRAPHY), and developed commercially by Ugo Basile.

The aim of this test is to characterize behavioral responses to mechanical/thermal stimuli to the vibrissal pad region of rats using a new model to evaluate orofacial nociception.

Animals are trained & tested in standard home cages; tests are performed in the presence of thermal or mechanical stimuli contacting the vibrissal pad, and the animals voluntarily place their face against either thermal or mechanical stimulator to access a reward, a bottle with condensed milk solution, whose snout is inserted through an opening.

A copper tubing shaped to contact the vibrissal pad region and warmed by heated water circulating through is used to deliver the thermal test stimulus; animals are tested over a temperature range of 40-63°C.

The mechanical stimuli is provided by an insert with 0-32 wires attached which make contact with the vibrissal pad region when the animal accesses the reward.

Following treatment to induce hypersensitivity, (e.g., trigeminal ligation or injection) trials are repeated to determine the effect of treatment on feeding behavior/reward. Assay sensitivity (inflammation-induced decreases in feeding behavior and reversal of hypersensitivity by local and systemic administration of analgesics) has been proven (Fehrenbacher et alia, in prep.); the feeding behavior is strongly correlated to mechanical or thermal orofacial nociception, as the animal must contact the stimulator in order to access the food reward.

A significant decrease in feeding time and increase in number of feeding attempts is observed with increasing temperature or with increasing mechanical force (higher number of wires), hence a decrease in feeding time can be evaluated as an increase in nociception.

This behavioral model will be a useful index of animal nociception and possible therapeutics in the orofacial region.

2 INSTRUMENT DESCRIPTION

The Ugo Basile Orofacial Stimulation Test quantifies feeding behavior by measuring and recording the beambreak number and duration (including min, max and mean), via the ORO-Software included (see paragraph 2.3-ORO-Software); the software acquires data from up to 16 cages simultaneously.

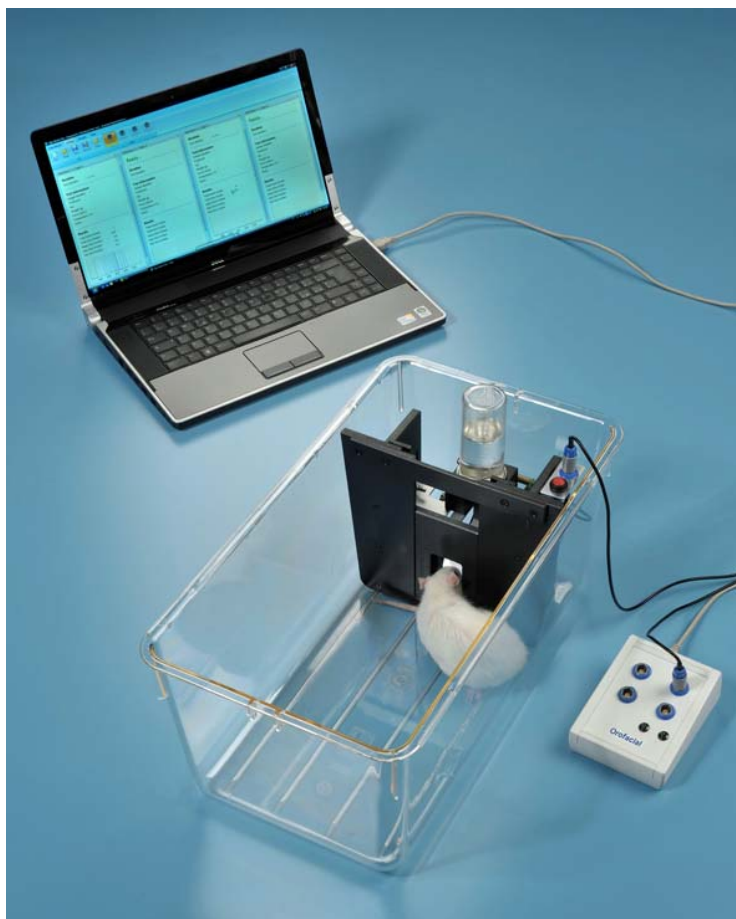

It's main features are:

- Mechanical and thermal nociception assays within the same experiment
- High throughput: up to 16 animals can be tested simultaneously
- Intact vibrissal pad, as the test does not require any shaving
- The ORO-Software, included as standard, manages up to 16 cages

Figure 1 "Orofacial Stimulation Set-Up"

2.1 System Components

The system basically consists of:

- **31300-001 Electronic Unit** for up to 4 cages
- **31300-002 Cage Assembly** (includes thermal and mechanical stimulators and feeding detector), see paragraph 2.2
- **31300-003 Circulating Water Bath**
- **31300-010 ORO-Software**, for data acquisition and analysis from up to 16 cages (4 electronic units), see paragraph 2.3.

2.2 Cage Assembly and Stimulation “Walls”

Either the thermal or the mechanical stimulator is mounted onto a stimulation/detection “wall”, which also incorporates a drinking bottle and fits inside standard rat home cages (e.g. Tecniplast or Allentown).



The **thermal stimulator** relies on a copper tubing loop and a circulating water bath, whose temperature can be adjusted from ambient to 70°C, to reach hot nociceptive threshold.

The picture shows the thermal stimulator, with chin insert to reduce the opening.



Figure 2 “Thermal Stimulator”

The mechanical stimulator relies on thin wires (*) attached to a mounting plate.

The system comes with 3 plates, each with a different number of wires in order to apply different force levels to the animal vibrissal pad.

See parts 6, 7 and 8, *Figure 6 "Wall Components"*.

* NiTi wire alloy NiTiCr ©, diam. 0,155 mm, straight annealed, surface oxide free



Figure 3 "Mechanical Stimulator"

Chin inserts are included to test animals of different size. Plastic masks are useful to reduce the opening, see parts 2, 3, 4 and 5, *Figure 6 "Wall Components"* in paragraph 3.4.1-Assembling the Stimulation Wall.

2.2.1 Optional Mouse Adaptor Kit

The stimulation walls have been designed and dimensioned to test rats: to carry out tests on mice a kit of adaptors for thermal and mechanical stimulation (Cat. No. 31300-323) is available as optional, see also paragraphs 6-ORDERING INFORMATION, and 3.4.3-Mouse Adaptor.

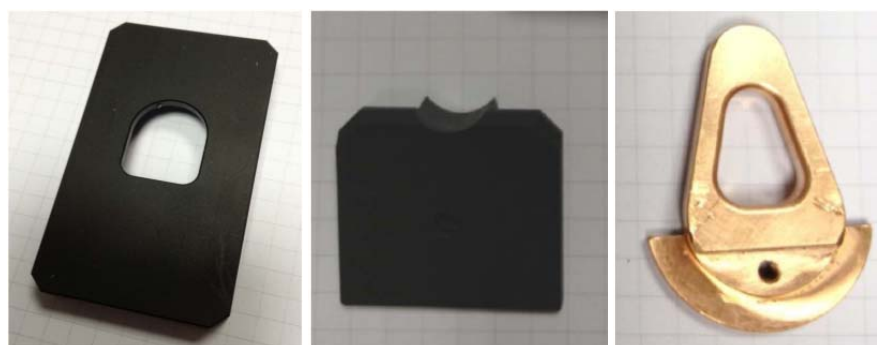

Figure 4 "Mouse Adaptors"

2.3 ORO-Software

The ORO-Software is included, loaded on the USB drive included in the Orofacial System standard package. It acquires data from up to 16 cages simultaneously (with 4 electronic units).

Data, shown in real-time both as numeric summary results and in a graphic format, are automatically analyzed across time according to an adjustable time window, independently viewable for each of the 16 cages.

The results of all the tests are available in a spreadsheet format which can easily be copied to other programs for further analysis.

The software also include an extensive HELP section, to guide you through the test and

data acquisition process.

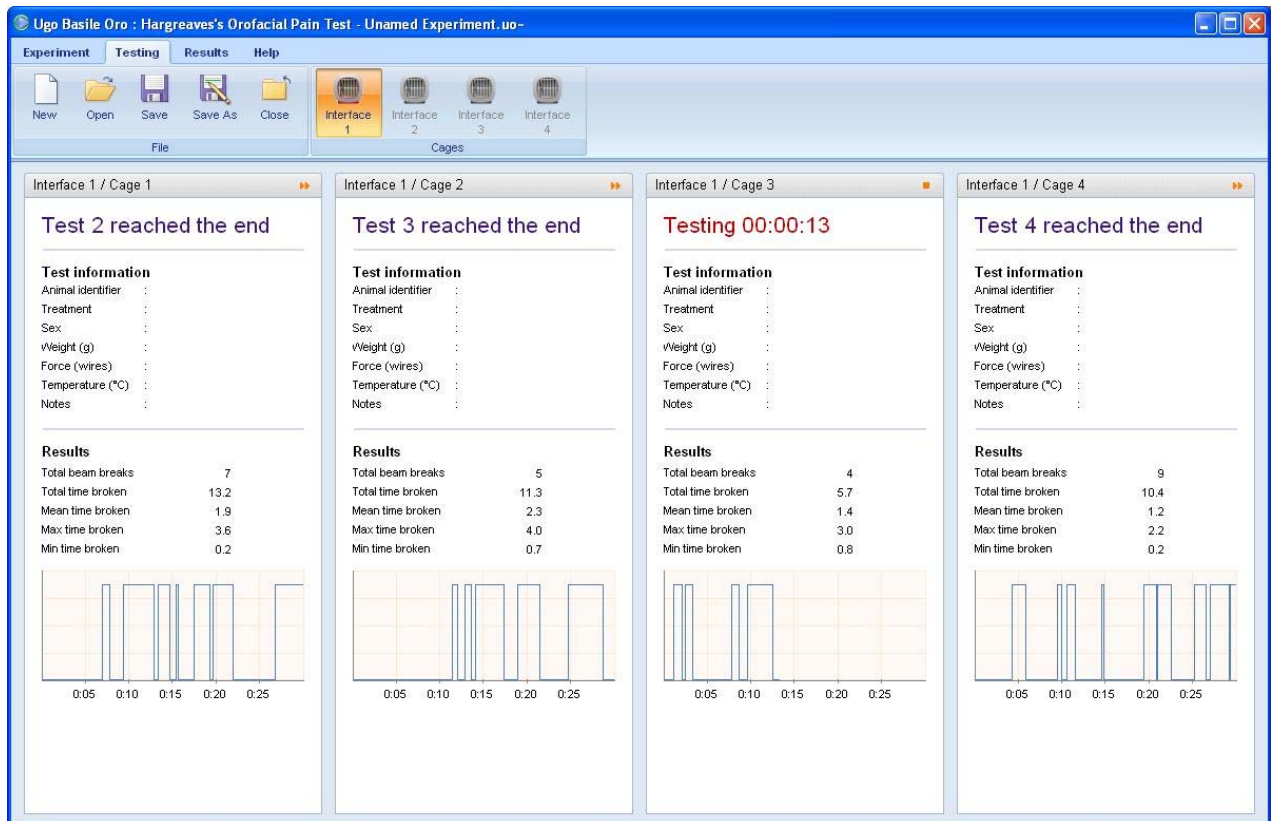

Figure 5 "Orofacial Software: testing window"

3 INSTALLATION

3.1 Unpacking & Preliminary Check

Check the contents of the shipment for completeness, packing list to hand, and visually inspect the instrument as soon you take it out of the packaging. Use the supplied **Check List**.

If the instrument is damaged, inform the carrier immediately, notifying our company. If after having tested it, the equipment fails to meet rated performances, please contact our after sales service, see paragraph 5.5-Customer Support.



Protect the environment!

Dispose of packaging properly, according to existing and applicable waste management rules and regulations.

3.2 Notes on the Instruction Manual

The 31300 Instruction Manual included in package (on the USB pen-drive) is necessary for the correct installation and operation of the instrument.

We recommend reading the manual with attention, as it is essential for the correct installation and operation of the instrument.

Please save the manual, ready to be consulted by the qualified personnel who use the instrument. Print it, only if necessary.

Our Instruction Manuals are available as free download on our website.

For any additional information and/or assistance, you are welcome to contact our Service Department (see paragraph 5.5-Customer Support), specifying the instrument serial number.

3.3 Recommended Operating Condition

Place the Orofacial Set-up in a room which is acoustically isolated or at least remote from sudden or intense noises; temperature is stimuli. Optimum temperature is 22-25°C.

The room should not be illuminated too brightly. In particular, avoid direct light on the Cage, e.g., from a table lamp. Like most behavioral tests, best practice is to carry out the experiment in the darkness or red light.

3.4 Setting-Up a Basic System

Assemble the Orofacial Stimulation Set-Up, positioning its components (cage, bath, electronic unit) on a stable bench or table surface.

Once the set-up is assembled, do not attempt to lift or move the combined unit; remove the connections first.

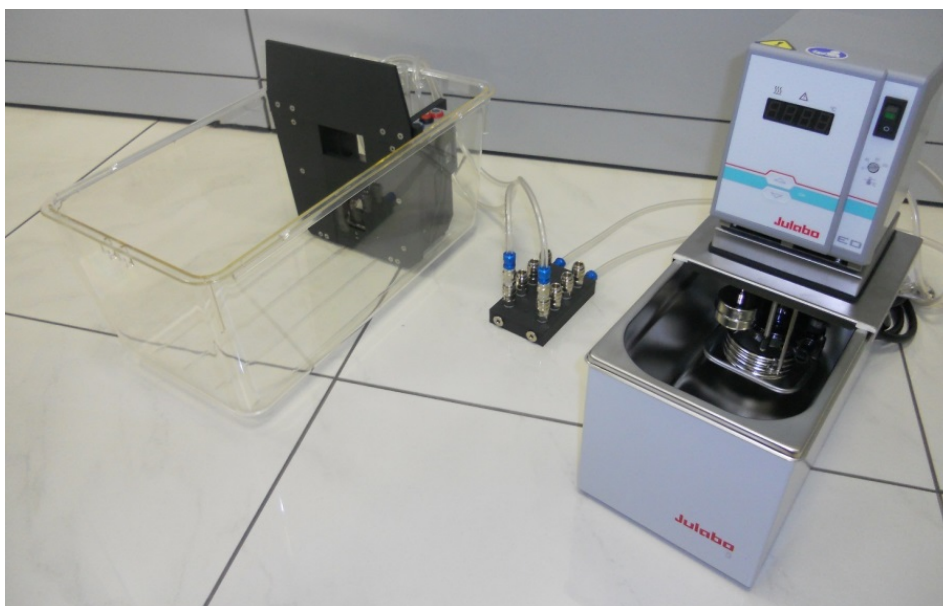

Setting-up a Standard System consists in assembling the stimulation wall, connecting all the parts electrically and hydraulically, and installing the software. The pictures in the following paragraph will guide you through the process.

3.4.1 Assembling the Stimulation Wall

First of all, assemble the thermal or the mechanical stimulator on the wall: see *Figure 6 "Wall Components"* and *Figure 7 "Assembling the stimulator on the wall"*.

Fit the black insert (1) onto the wall. Position the spacers provided, above or below the black insert, to position the stimulator at the correct height, depending on the animal size.

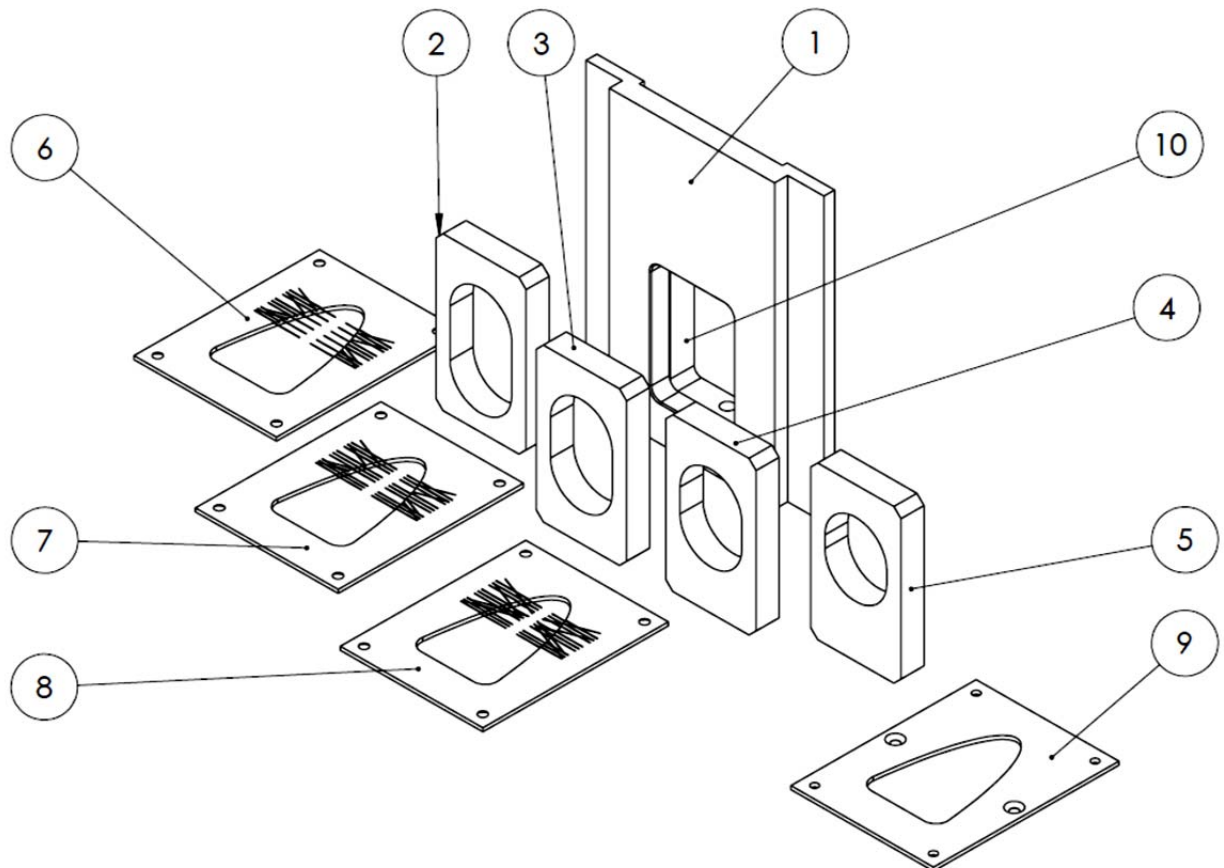
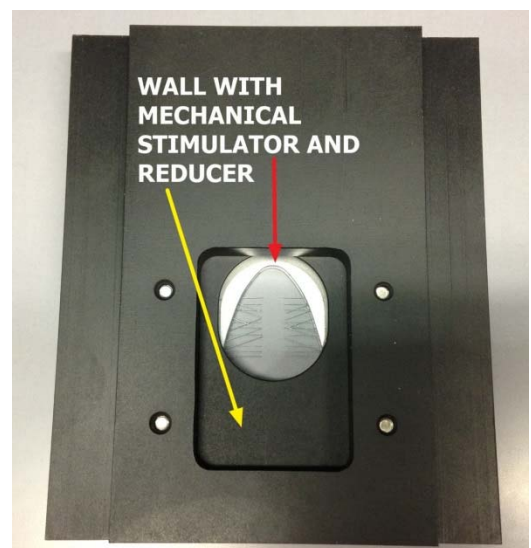

Figure 6 "Wall Components"

If necessary, insert one of the black plastic adaptors (2, 3, 4 or 5) provided, to adjust the opening to the animal size and shape.

See an example in the picture on the right.



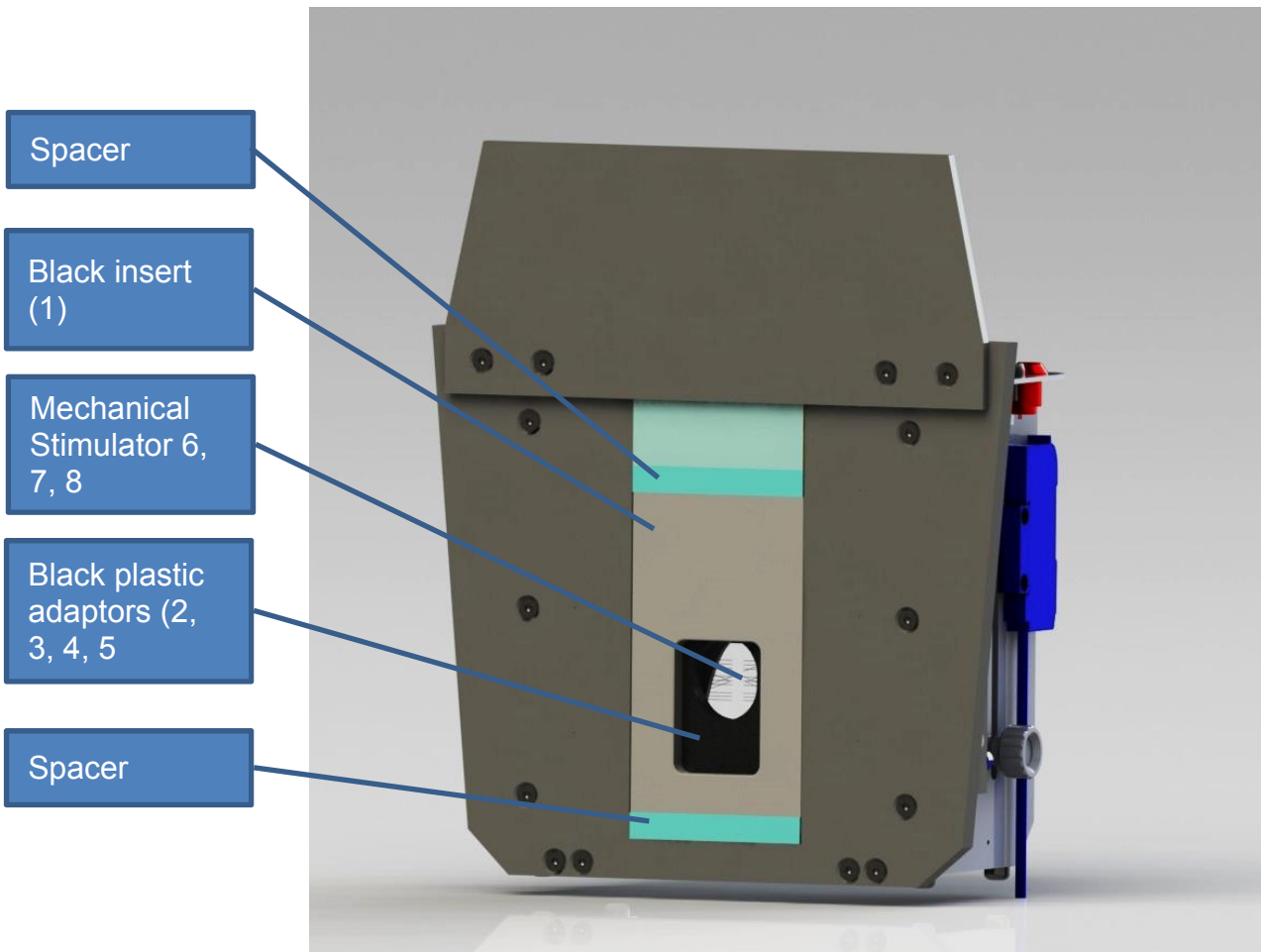
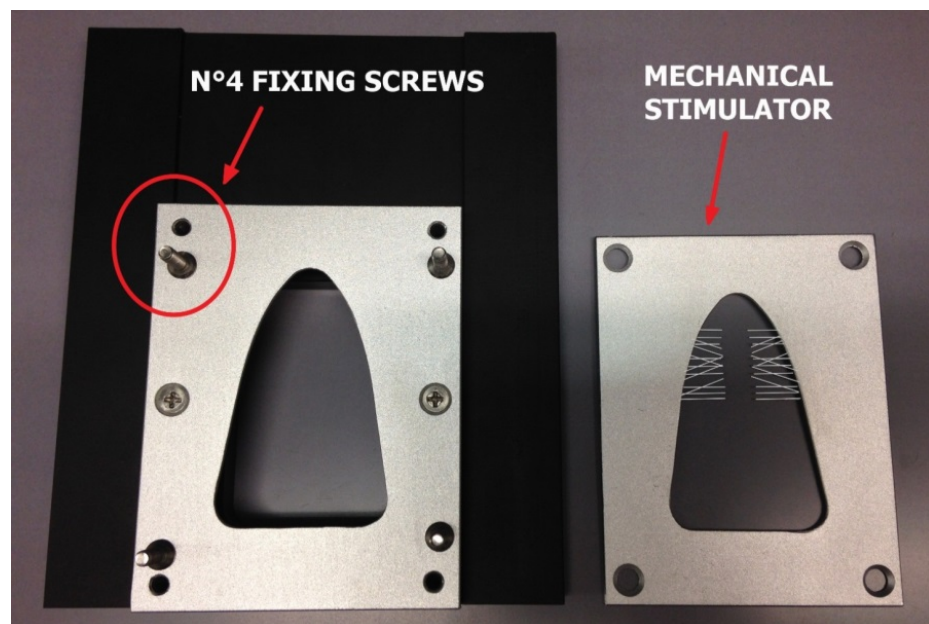

Figure 7 "Assembling the stimulator on the wall"

For the mechanical stimulator, chose the mask more suitable for your test (see parts 6, 7 and 8, *Figure 6 "Wall Components"*), and fit it on the blank mask (the one without wires, part 9), so as to form a sort of "sandwich", fix it via the 4 screws indicated in the picture.



The blank mask is used alone, in the habituation phase.

Position the drinking bottle (A) on its holding block (B) and fix it by the two knurled knobs provided (C).

Via the knurled knobs (D), adjust the height, so that the bottle spout is centred respect to the opening.

Finally move backward or forward the block holding the bottle, via the knobs (E), until you find the correct position.

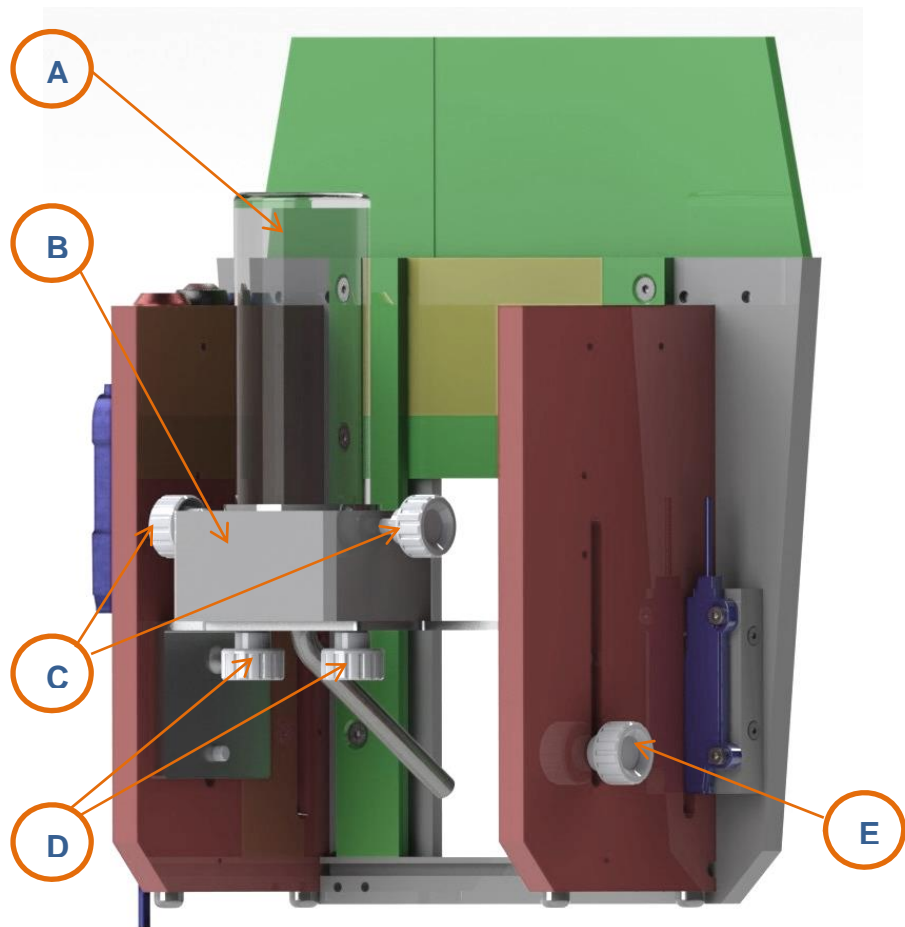

Figure 8 "Positioning the Drinking Bottle"

3.4.2 Hydraulic Connections

When thermal stimulation is taken into consideration, the stimulation wall should be connected to the water heating/circulating bath, via the tubing provided.

The thermal stimulator (the shaped copper tubing) is provided with inlet and outlet connector (no differentiation).



If more than one cage is connected to the water bath, you will need the 31300-320 warm water distributor including as standard in 2 and 4-cage systems.

The picture shows how to fit the tubing. The ports indicated in the picture as “INPUT” and “OUTPUT” connect the distributor to the heating/circulating bath.

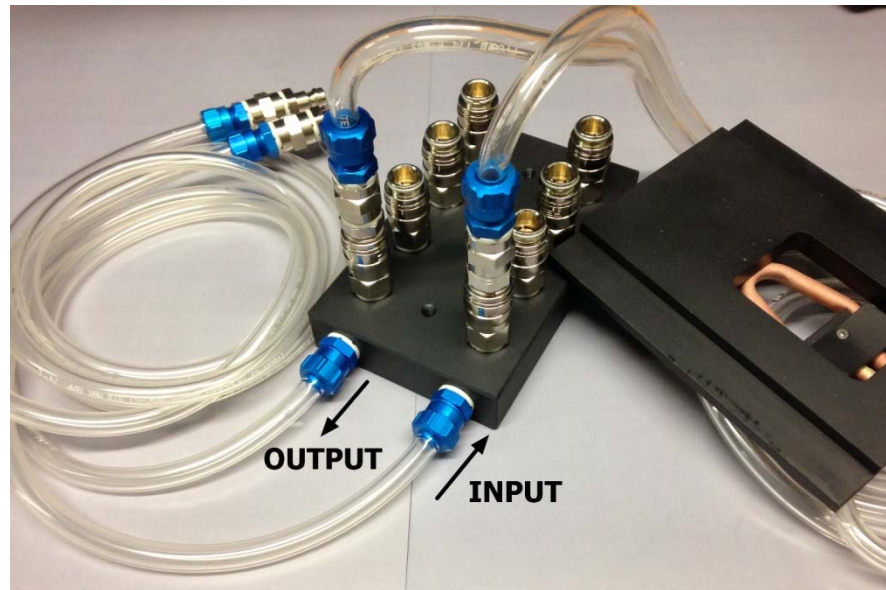

After connecting the tube to the mechanical stimulator, fix them into the brackets provided, as shown on the picture on the right.

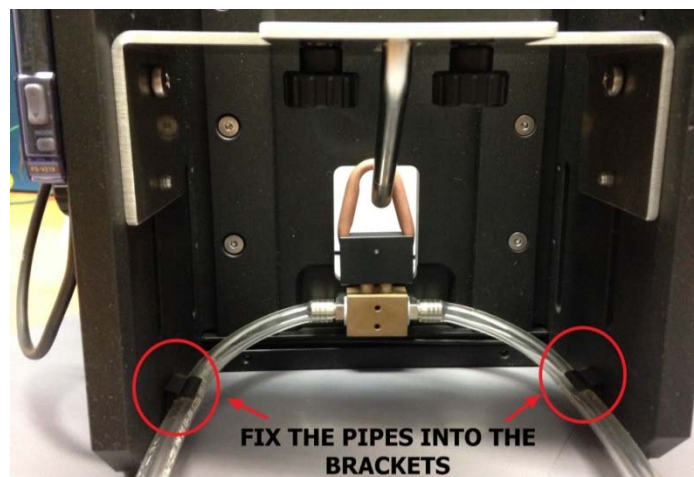

3.4.3 Mouse Adaptor

When testing mice, use the optional mouse adaptor kit 31300-323, see also paragraph 2.2.1.

The picture shows how the adaptors should be fitted on the mechanical and thermal stimulators respectively.



3.4.4 Electrical Connections

Via the cable/s provided, connect each wall's red connector (marked in the picture as "power supply") to one of the panel input on the electronic unit.

Connect the pedal switch to the blue connector on the stimulation wall.

Connect the universal power supply to the back of the electronic unit.

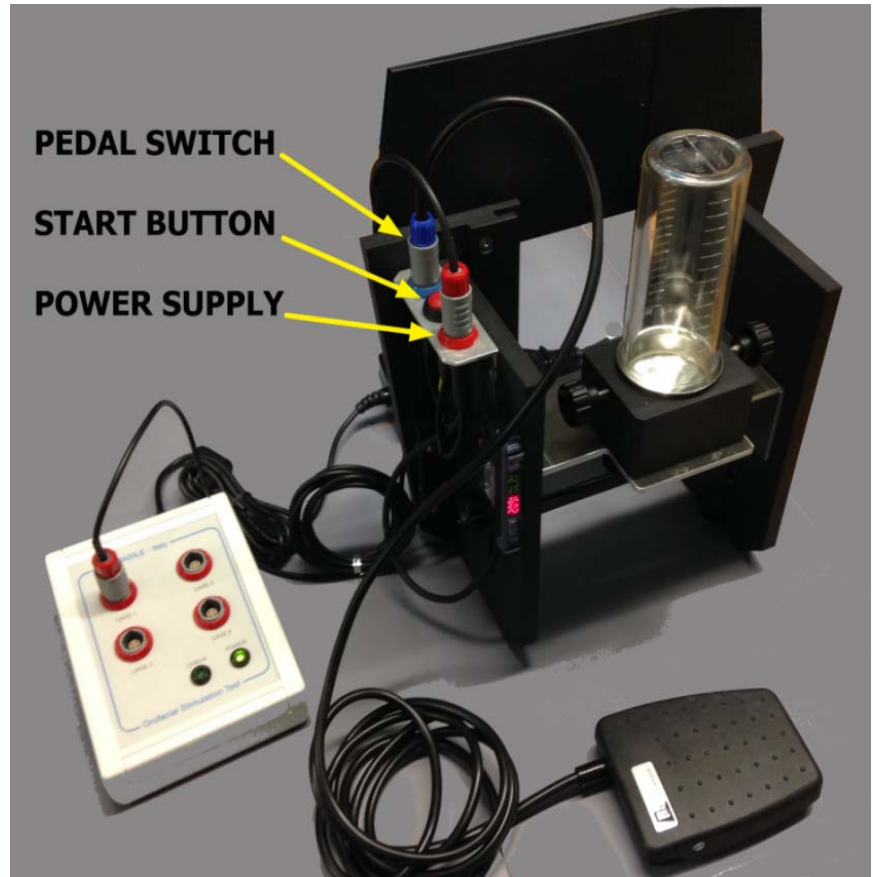

3.4.5 Installing the ORO Software

The ORO software is saved on the USB drive provided with the set-up. An autorun procedure should start when the USB drive is opened.

If this doesn't happen, execute the file "CDautoplay.exe", and follow the procedure to install the drives and the program.

3.5 Intended Use

The Orofacial Set-Up is intended for investigation use on **laboratory animals only**.

3.6 General Safety Instructions

The following guidelines must be followed to ensure safe operation.

- ! **DO NOT** attempt to open or perform any service work
- ! **DO NOT** connect up human subjects



3.7 Additional Safety Consideration

- a. Use original accessories and spare parts only, see also paragraph 6-ORDERING INFORMATION
- b. Do not operate the instrument in hazardous environments or outside prescribed environmental limitations (i.e. +18C°/+24C°, 60% relative humidity, non-condensing);
- c. Do not spray any liquid on the connectors;
- d. Keep inflammables far from the instruments.

UGO BASILE DOES NOT ACCEPT ANY RESPONSIBILITY FOR PROBLEMS OR HARM CAUSED TO THINGS OR PERSONS, ARISING FROM:

- incorrect electrical supply;
- incorrect installation procedure;
- incorrect or improper use or, in any case, not in accordance with the purpose for which the instrument has been designed and the warnings stated in the instruction manual supplied with the instrument;
- replacement of original components, accessories or parts with others not approved by the manufacturer;
- servicing carried out by unauthorized personnel

see also paragraph 5-MAINTENANCE.

4 OPERATION

4.1 Switching-On

The instrument is automatically switched on when connected to the mains, via the power cord and power supply provided.

In case of thermal stimulation, switch on the water bath and set the desired temperature.

4.2 Testing the Animal

When, after an habituation session, you are ready to start the test with the animal, press the start button, or the pedal switch, which has the same function.

The test will last for the duration set on the ORO software.

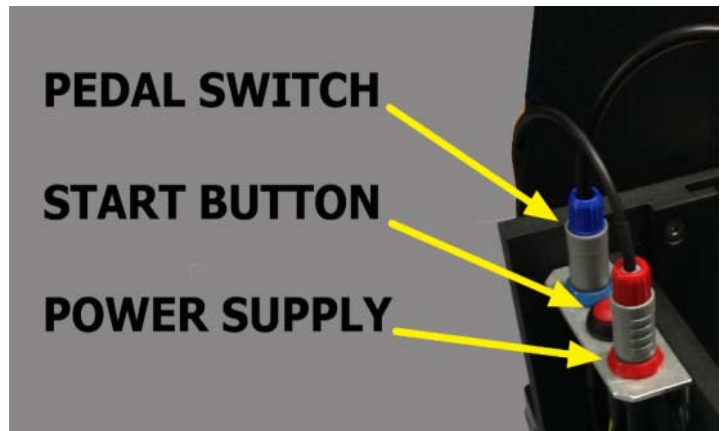

For instructions on how to set the experiment, collection and manage data, please refer to the ORO-software HELP section.

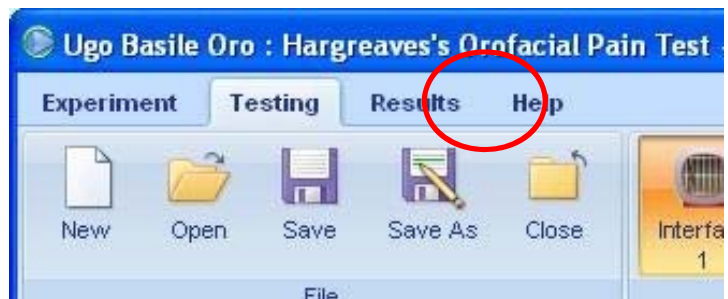

4.3 Calibration

The Orofacial stimulation test is factory calibrated.

Should a calibration become necessary, proceed as described below:

- a. Insert in the opening an object which can indicatively replicate the animal nose,

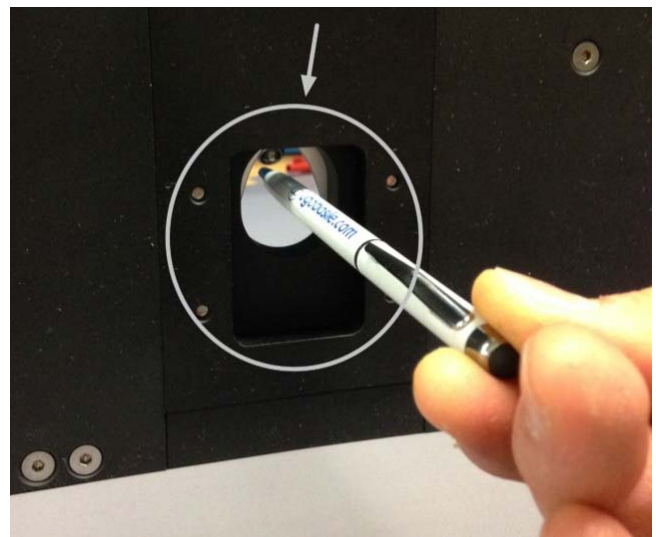

- b. Press the “set” key on the fiber-optic sensor

In this way the minimum area to trigger the optical sensor is set.

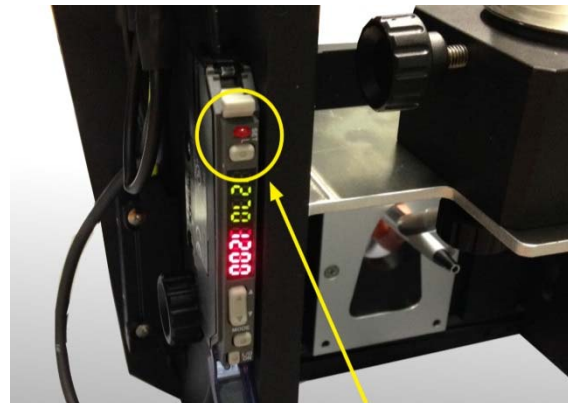

5 MAINTENANCE

Ugo Basile Orofacial Stimulation System is covered by a 24-month warranty. Service, if necessary, has to be done by authorized UB personnel only; servicing by anyone other than an authorized service facility will void the warranty.

If a problem occurs, contact your representative, see paragraph 5.5-Customer Support.



UNPLUG THE MAINS CORD BEFORE CARRYING OUT ANY MAINTENANCE JOB!

5.1 Cleaning and Sterilization

Do not use alcohol, liable to impair the Perspex sheets and to crack the acrylic front panel of the liquid crystal display.

Cotton wool and water can be used for cleaning purposes. For disinfection, use a non-alcoholic disinfectant, or H₂O₂.

5.2 Disposal of Old Electrical & Electronic equipment

Applicable in the European Union and other European countries with separate collection systems



This product shall not be treated as household waste. To reduce the environmental impact of WEEE (Waste Electrical and Electronic Equipment) and minimize the volume of WEEE entering landfills, please reuse and recycle.

Send to a recycling center equipped to handle electronics.

5.3 Abnormal conditions

Operate the instrument only as intended by the manufacturer. If you suspect the instrument protection has been impaired, disconnect the power cord and secure the instrument against any unintended operation.

The protection is likely to be impaired if, for example, the instrument shows visible damage or has been subjected to severe transport stress. Proper use of instrument depend on careful reading of all instruction and labels.

5.4 Long Inactivity

The instrument does not require any particular maintenance after long inactivity.

5.5 Customer Support

For any further information you may desire concerning the use and/or maintenance of the Set-Up, please do not hesitate to contact our **service department** (or our local distributor) either directly or via our support page <http://www.ugobasile.com/support.html> :



UGO BASILE s.r.l.

Via G. Di Vittorio 2
21036 GEMONIO – Varese, ITALY



Phone : +39 0332 744574



service@ugobasile.com
logistics@ugobasile.com
sales@ugobasile.com

Before sending any instrument to our factory for repair, please contact our logistics department to obtain a return authorization number (RMA) and shipping/packing instructions.

We may not be held responsible for damages during transport due to poor packing; whenever possible, please use the original packing.

6 ORDERING INFORMATION

- 31300 Orofacial Stimulation Test, Complete System for one animal
- 31320 Orofacial Stimulation Test, Complete System for two animals
- 31340 Orofacial Stimulation Test, Complete System for four animals
- 31300-001 Electronic unit (four channels)
- 31300-002 Additional cage assembly (includes thermal and mechanical stimulators and feeding detector)

- 31300-003 Circulating water bath, including connection kit 31300-321
- 31300-320 Water Distributor (for 2 and 4-cage systems only)
- E-AU 041 USB pen-drive, including
 40570-302 Instruction Manual
 31300-010 ORO-Software, for data acquisition and analysis from up to 16 cages

6.1 Optional

- 31300-323 Kit of Mouse adaptors for thermal and mechanical stimulation (for 1 cage)

7 INSTRUMENT SPECIFICATIONS

Water Temperature	can be adjusted from ambient to 70°C
Mechanical Stimulation	3 mechanical stimulators with different wire number, and 1 blank
Oro Software	collects and records beam-break number and duration from up to 16 cages simultaneously.
Operating Temperature	10° to 40°C
Sound Level	Negligible
Pollution Degree	≤ 2

Physical

Net weight	31300	13Kg
	31320	23Kg
	31340	38Kg
Shipping Weight	31300	15Kg
	31320	28Kg
	31340	43Kg

Warranty

31300 systems are covered by a 24-month warranty

8 BIBLIOGRAPHY

- K. Thibault et alia: **“Orofacial Neuropathic Pain Leads to a Hyporesponsive Barrel Cortex with Enhanced Structural Synaptic Plasticity”** PlosOne 0160786, **2016**
- Q. Zhang et alia: **“Chemokine CXCL13 Mediates Orofacial Neuropathic Pain via CXCR5/ERK Pathway in the Trigeminal Ganglion of Mice”** J. Neuroinflammation 183: 2-13, **2016**
- A.A. Abd-Elsayed et alia: **“KCNQ channels in nociceptive cold-sensing trigeminal ganglion neurons as therapeutic targets for treating orofacial cold hyperalgesia”** Molecular Pain 45: 2-11, **2015**
- M. Prochazkova et alia: **“Activation of Cyclin-Dependent Kinase 5 Mediates Orofacial Mechanical Hyperalgesia”** Molecular Pain 9:66: 1-12, **2013**
- X.Z. Zuo et alia: **“Operant Behavioral Responses to Orofacial Cold Stimuli in Rats with Chronic Constrictive Trigeminal Nerve Injury: Effects of Menthol and Capsazepine”** Molecular Pain 28: 2-8, **2013**
- M. Cha et alia: **“Assessment of Chronic Trigeminal Neuropathic Pain by the Orofacial Operant Test in Rats”** Behav. Brain Research 234: 82-90, **2012**
- J.C. Fehrenbacher et alia: **“Characterization of a novel orofacial behavioral assay to assess hyperalgesia to thermal and mechanical stimulation”**. (*submitted*).



ugo basile®

TRANSFORMING IDEAS
INTO INSTRUMENTS

CE CONFORMITY STATEMENT

Manufacturer **UGO BASILE srl**
Address Via G. di Vittorio, 2 – 21036 Gemonio, VA, ITALY
Phone n. +39 0332 744574
Fax n. +39 0332 745488

We hereby declare that

Instrument. **OROFACIAL STIMULATION TEST**
Catalog number **31300 – 31320 - 31340**

*is manufactured in compliance with the following European Union Directives
and relevant harmonized standards*

- *2006/42/CE on machinery*
- *2014/30/UE relating to electromagnetic compatibility*
- *2011/65/UE and 2015/863/UE on the restriction of the use of certain hazardous substances in electrical and electronic equipment*

Account Manager

Mauro Uboldi

Nome / Name

October 2018

Date

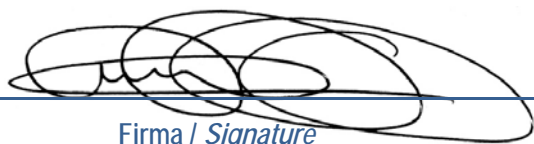

Firma / Signature