



ugo basile®

TRANSFORMING IDEAS
INTO INSTRUMENTS

instruction manual

Bronchospasm Transducer
Cat. No. 17020

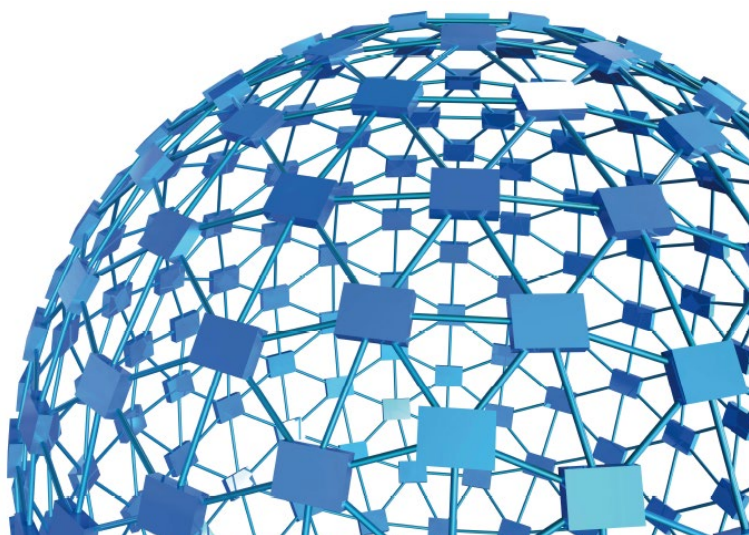

UGO BASILE S.R.L.

sales@ugobasile.com / service@ugobasile.com www.ugobasile.com

UGO BASILE S.R.L.

Via Di Vittorio, 2
21036 GEMONIO, VA, ITALY
Phone: +39 0332 744574

sales@ugobasile.com / service@ugobasile.com
www.ugobasile.com

instruction manual

**Bronchospasm Transducer
Cat. No. 17020**

Serial No.

SAFETY CONSIDERATIONS

ALTHOUGH THIS INSTRUMENT HAS BEEN DESIGNED WITH INTERNATIONAL SAFETY STANDARD, THIS MANUAL CONTAINS INFORMATION, CAUTIONS AND WARNINGS WHICH MUST BE FOLLOWED TO ENSURE SAFE OPERATION AND TO RETAIN THE INSTRUMENT IN SAFE CONDITIONS.

SERVICE AND ADJUSTMENTS SHOULD BE CARRIED OUT BY QUALIFIED PERSONNEL, AUTHORIZED BY UGO BASILE ORGANIZATION.

ANY ADJUSTMENT, MAINTENANCE AND REPAIR OF THE OPENED INSTRUMENT UNDER VOLTAGE SHOULD BE AVOIDED AS MUCH AS POSSIBLE AND, WHEN INEVITABLE, SHOULD BE CARRIED OUT BY A SKILLED PERSON WHO IS AWARE OF THE HAZARD INVOLVED.

CAPACITORS INSIDE THE INSTRUMENT MAY STILL BE CHARGED EVEN IF THE INSTRUMENT HAS BEEN DISCONNECTED FROM ITS SOURCE OF SUPPLY.



ugo basile®

TRANSFORMING IDEAS
INTO INSTRUMENTS

www.ugobasile.com

VENTILATORS and GAS ANESTHESIA

Bronchospasm Transducer

New model for digital recorders

Cat. No. 17020

General

This transducer is designed to perform the bronchospasm test on laboratory animals and is particularly suitable for connection to UGO BASILE DataCapsule-Evo Recorder, and to other digital data acquisition systems.

It enables the research worker to evaluate the spasm-inducing effect of drugs having a very wide range of action, not necessarily intended to act on respiratory dynamics.

The Bronchospasm Transducer 17020 is also a useful research tool for screening substances inducing the opposite effect, both those causing active bronchodilation in basal conditions and those which antagonize test drugs such as histamine, bradykinin, etc.

It is basically an air flow meter provided with a water input valve with adjustable pressure threshold.

The measuring device is a compact unit made entirely of Perspex; power supply and controls are located in a separate electronic box.

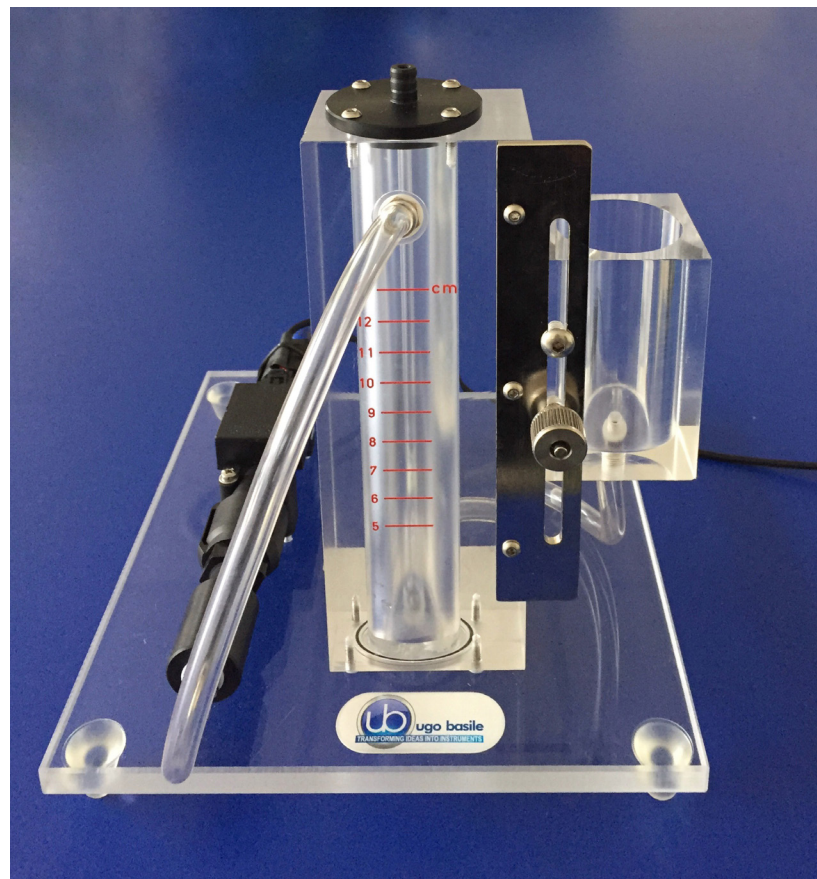

- Evaluates the bronchospasm inducing effect of drugs
- The new model records the volume (with a precision of 0.1 ml)

Main Features

- Simple and reliable method to assess airflow resistance
- The effect of bronchodilators agents is quickly assessed
- A complete set-up includes optional animal ventilator and data acquisition system (or chart recorder). Ask for details!

Ugo Basile: more than 25,000 citations



ugo basile®
TRANSFORMING IDEAS
INTO INSTRUMENTS

CHECK-LIST

Cat. No. 17020 Bronchospasm Transducer

CLIENTE / CUSTOMER _____

Ordine No. / Order No. _____ Data / Date ____ / ____ / ____

UB code	CAT.No.	✓	Q.ty	DESCRIPTION	DESCRIZIONE
	17020-001		1	CONTROLLER	UNITÀ DI CONTROLLO
	17020-002		1	AIR FLOW DETECTOR	AIR FLOW DETECTOR
E-AU 041 USB pen-drive	17020-302		1	INSTRUCTION MANUAL	MANUALE D'ISTRUZIONE
E-WP 008				MAINS CABLE	EUROPE CAVO RETE
E-WP 008-1					U.S.A. EUROPA U.S.A.
E-FT 007-1			2	FUSE (T630mA 6X32)	FUSIBILE (T630mA 6X32)

DATE / /	Serial No.	IMBALLATO DA / PACKED BY
Universal Input 85-264 VAC, 50-60Hz		

IMPORTANT/IMPORTANTE:

Check the shipment for completeness immediately after receipt: should you find any discrepancy, please fill in the following part and transmit it to our fax no. **+39 0332 745488**

Al ricevimento della merce controllate che la spedizione sia completa: in caso di discrepanza, completate il formulario di seguito riportato ed **inviatelo** al nostro fax no. **0332 745488**

FROM: Name	Company/Institution
DATE	REF.

NOTE

CONTENTS

1	GENERAL	1
1.1	RATIONALE OF THE TECHNIQUE.....	1
2	INSTRUMENT DESCRIPTION	2
2.1	CONTROL UNIT 17020-001	2
2.2	AIR-FLOW METER	2
3	DATA ACQUISITION	4
4	INSTALLATION	4
4.1	UNPACKING & PRELIMINARY CHECK	4
4.2	NOTES ON THE INSTRUCTION MANUAL	5
4.3	GENERAL SAFETY INSTRUCTIONS.....	5
4.4	INTENDED USE	5
4.5	ADDITIONAL SAFETY CONSIDERATION	5
4.6	ASSEMBLING THE INSTRUMENT	6
4.7	BEFORE APPLYING POWER.....	6
4.7.1	FUSE HOLDER	6
4.7.2	MAIN SWITCH	6
4.7.3	MAINS CORD	6
4.7.4	CONNECTIONS, BACK PANEL	7
5	OPERATION	7
5.1	AERODYNAMIC COMPATIBILITY	7
5.2	PREPARING THE EXPERIMENT	7
6	MAINTENANCE	8
6.1	ELECTRICAL	8
6.2	CLEANING THE AIR-FLOW DEVICE	8
6.3	LONG INACTIVITY	8
6.4	CUSTOMER SUPPORT	9
7	ORDERING INFORMATION	9
7.1	OPTIONAL	9
8	INSTRUMENT SPECIFICATIONS	9
9	BIBLIOGRAPHY	10
9.1	METHOD PAPER.....	10

9.2 PAPERS DEALING WITH UGO BASILE BRONCHOSPASM TRANSDUCER..... 10

FIGURE INDEX

Figure 1 “Bronchospasm Set-Up” 3
Figure 2 “Sample of Recording” 4

Bronchospasm Transducer

Cat. 17020

1 GENERAL

The 17020 transducer is designed to perform the bronchospasm test on guinea pigS and is particularly suitable to work in connection with Ugo Basile digital recorder 17308 Data-Capsule, and with our Rodent Ventilator 7025.

It enables the research worker to evaluate the spasm inducing effect of drugs having a very wide range of action, not necessarily intended to act on respiratory dynamics.

When a central analgesic agent is administered to the animal, reaction time is markedly increased.

The Bronchospasm Transducer 17020 is also a useful research tool for screening substances inducing the opposite effect, both those causing active bronchodilation in basal conditions and those which antagonize test drugs such as histamine, bradykinin, etc.

It is basically an air-flow meter provided with a water input valve with an adjustable pressure threshold, connected to the forced respiration piping via a by-pass.

1.1 Rationale of the Technique

The experimental layout follows the well-known Konzett Roessler protocol (H. Konzett and R. Roessler - Arch. Exp. Path. Pharmacol., 195 (1): pp 71-74, 1940, see paragraph 9.1-Method Paper) with the anaesthetized guinea pig breathing via a reciprocating pump, according to Starling's mode of operation.

Any reciprocating or bellow-type Starling's pump is suitable, provided it is capable of delivering up to 10 ml per stroke, at frequencies ranging from 30 to 70 strokes per minute. The Ugo Basile 7025 RODENT VENTILATOR is particularly suitable.

Neither tubing gauge nor by-pass location are critical.

2 INSTRUMENT DESCRIPTION

The 17020 Bronchospasm Transducer comes as a complete package including:

- the **Control Unit**
Cat. 17020-001 (see 2.1)
- the **Air-flow Meter**
Cat. 17020-002 (see 2.2)

See picture.



2.1 Control Unit 17020-001

The Control Unit encompasses power supply and controls.

The “**POWER**” Led indicates that the instrument is ON.

The “**TIME**” knob enables the user to set the time after which the integrated signal of the flow sensor is reset after the spasm has occurred.

The back panel assembles all connections, see paragraph 4.7.4.



2.2 Air-flow Meter

The air flowmeter is made entirely of Perspex (see picture), encompassing the flow sensor, is mounted on a base, and connects to the control unit.

The system operates as follows: pressure pulses in the by-pass connection brought about by the operation of the pump cause the water column C in glass tube T to oscillate.

This in turn leads the water level in the valve body to rise and fall and consequently air is expelled and drawn in through the nozzle N, see Figure 1.

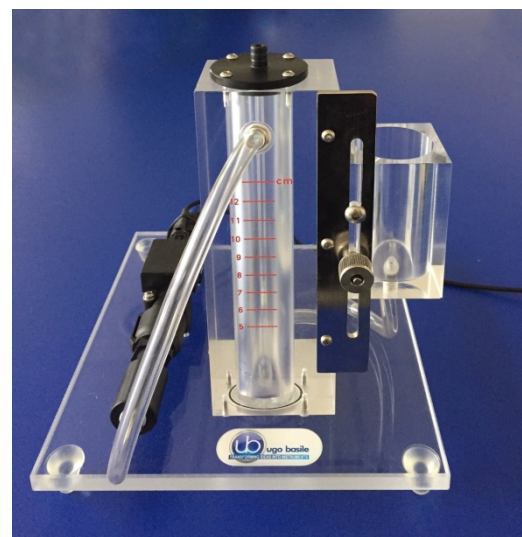

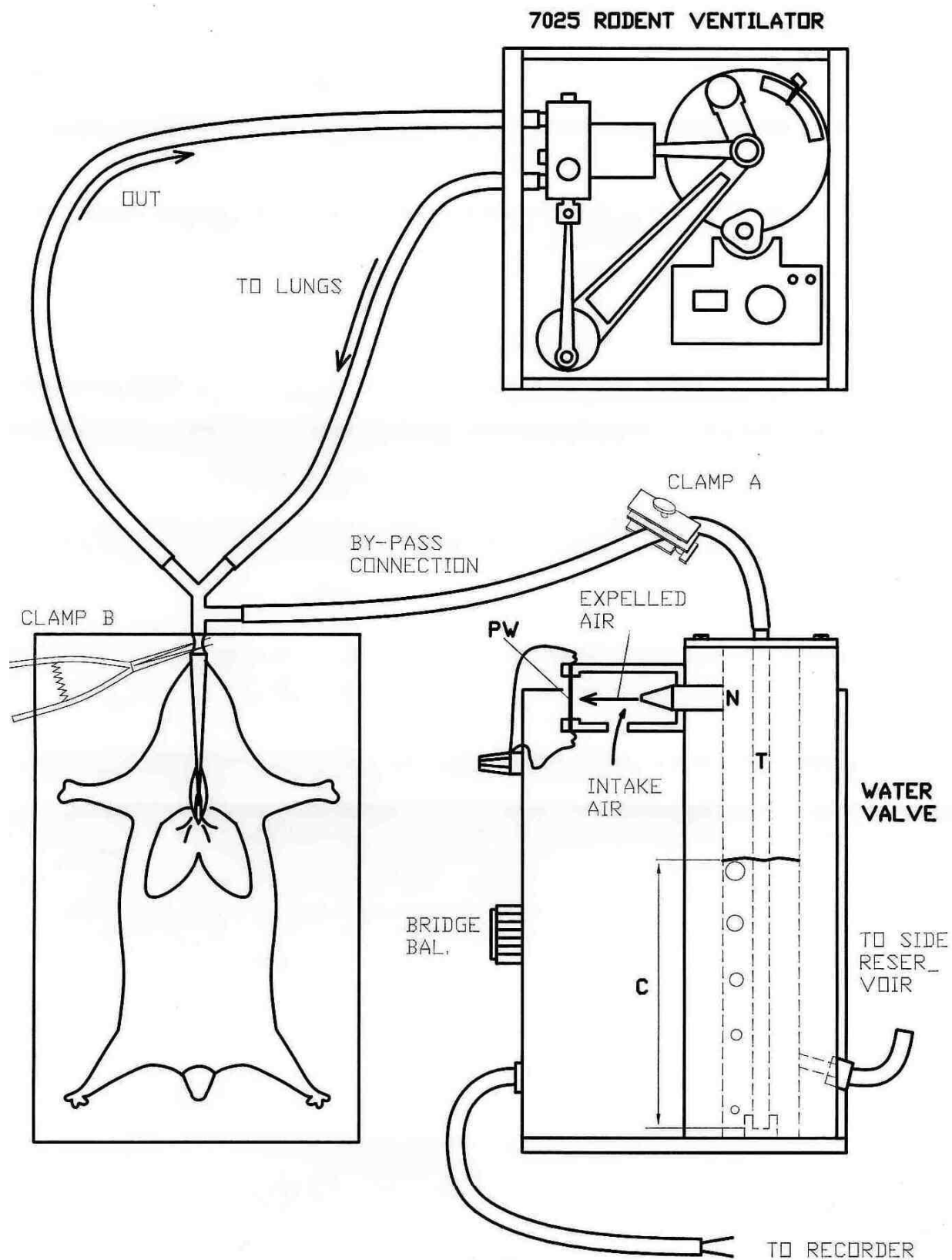

Figure 1 "Bronchospasm Set-Up"

Intake air follows the pattern indicated the figure, while expelled air hits PW and is measured in the process.

When aerodynamic alterations take place in the bronchi, inspiration pressure pulses acting on the water column C change their intensity, thus air is expelled at different rates, producing a trace of narrower or wider amplitude.

In particular, when bronchodilators are administered, pressure pulses are reduced to below normal breathing values, as the bronchi exert less aerodynamic resistance to forced inspiration

The tracing will decrease in amplitude to a marked degree, enabling the action of bronchodilators to be assessed.

When broncho-constrictors are administered and bronchospasm occurs, a quantity of air delivered by the pump and not accepted by the lungs, finds its way out via the by-pass connection: it displaces the water column from tube T and bubbles through the water, thus producing a tracing of much wider amplitude than that caused by oscillations of the water column.

3 DATA ACQUISITION

The 17020 is provided with a BNC connector for branching it to our 17308 Digital Recorder DataCapsule-Evo. See paragraph 7.1-Optional.

The recorder monitors respiration dynamics by providing a tracing appearing as a succession of "spikes", see Figure 2.

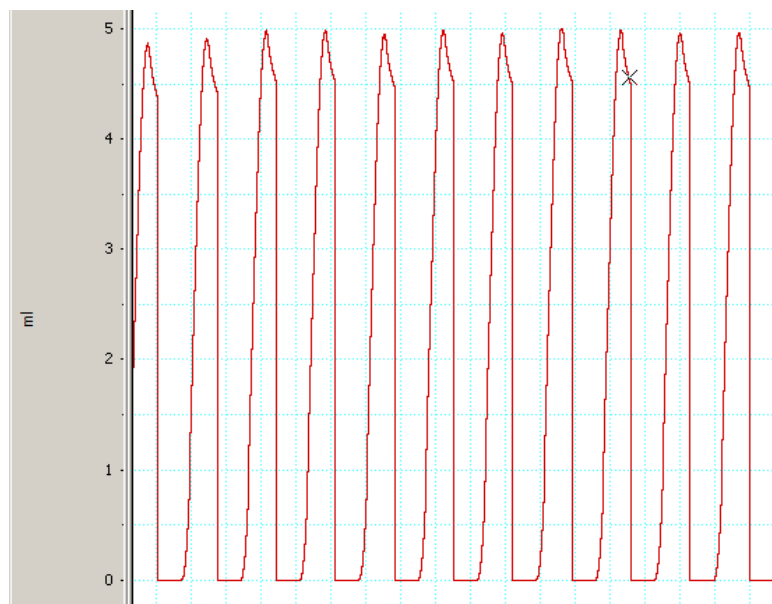

Figure 2 "Sample of Recording"

4 INSTALLATION

4.1 Unpacking & Preliminary Check

Check the contents of the shipment for completeness, packing list to hand, and visually inspect the instrument as soon you take it out of the packaging. Use the supplied **Check List**.

If the instrument is damaged, inform the carrier immediately, notifying our company. If after having tested it, the instrument fails to meet rated performances, please contact our after sales service.



Protect the environment!

Dispose of packaging properly, according to existing and applicable waste management rules and regulations.

4.2 Notes on the Instruction Manual

The 17020 Instruction Manual included in the package (on the USB pen drive) is necessary for the correct installation and operation of the instrument.

We recommend reading the manual with attention, as it is essential for the correct installation and operation of the instrument.

Please save the manual, ready to be consulted by the qualified personnel who use the instrument. Print it, only if necessary.

Our Instruction Manuals are available as free download on our web. For any additional information and/or assistance, you are welcome to contact our Service Department specifying the serial number of your instrument.

4.3 General Safety Instructions

The following guidelines must be followed to ensure safe operation.

- ! **DO NOT** attempt to open or perform any service work
- ! **DO NOT** connect up human subjects



4.4 Intended Use

The device is intended for investigation use on **laboratory animals only**.

4.5 Additional Safety Consideration

- a. Use original accessories and spare parts only, see also paragraph 7-ORDERING INFORMATION.
- b. Do not operate the instrument in hazardous environments or outside prescribed environmental limitations (i.e. +18C°/+24C°, 60% relative humidity, non-condensing);
- c. Do not spray any liquid on the connectors;
- d. Keep inflammables far from the instruments.

UGO BASILE DOES NOT ACCEPT ANY RESPONSIBILITY FOR PROBLEMS OR HARM CAUSED TO THINGS OR PERSONS, ARISING FROM:

- incorrect electrical supply;
- incorrect installation procedure;

- incorrect or improper use or, in any case, not in accordance with the purpose for which the instrument has been designed and the warnings stated in the instruction manual supplied with the instrument;
- replacement of original components, accessories or parts with others not approved by the manufacturer;
- servicing carried out by unauthorized personnel, see also paragraph 6-MAINTENANCE.

4.6 Assembling the Instrument

Put the instrument on a stable and flat bench or table surface. Position onto the base plate the animal restrainer supplied with the instrument.

4.7 Before Applying Power

Consider the Power Module on the back panel of the Control Unit, which includes (from left to right):

- the inlet connector
the mains cord
- the mains switch
- the fuse holder

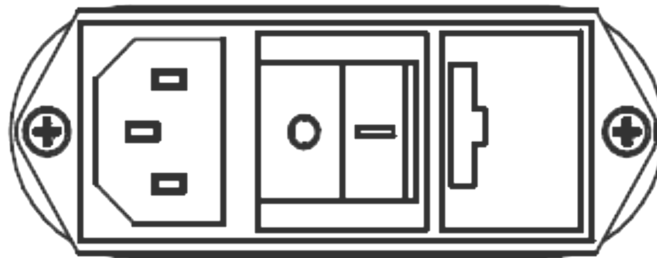

"Power Module"

4.7.1 Fuse Holder

The instrument is provided with 2 fuses, on both neutral and live. To replace fuses, if necessary, pull out the fuse slide, see paragraph 6.1-Electrical.

It is recommended to use fast-blow fuses type F630mA; make sure that only fuses with the required rated current and of the specified types are used for replacement. The use of repaired fuses and the short circuiting of the fuse holders must be avoided.

4.7.2 Main Switch

This two-pole toggle switch, which complies with international safety standards, provides a visual cue, to signal the:

- **OFF** position by **○**
- **ON** position by **I**

4.7.3 Mains Cord

It is a standard cable, Cat. # E-WP008. Make sure your power outtake is provided with a reliable ground connection.

4.7.4 Connections, Back Panel

The connection module encompasses, from left to right:

- BNC** this BNC provides the air flow signal, and connects to the Recorder, see also paragraphs 3-DATA ACQUISITION and 5.2-Preparing the Experiment
- LEMO** a 4 pins socket, for connecting the Air-Flow Device to the Controller via the cable provided.

5 OPERATION

5.1 Aerodynamic Compatibility

Constant pressure Ventilators are available on the market, which are useful in some physio/pharmacological investigations but are definitely non compatible with 17020.

The Bronchospasm Test requires a Constant volume Ventilator, i.e., a Starling's Pump, such as the Ugo Basile 7025 Rodent Ventilator, which is particularly suitable.

In fact, suppose to connect a constant pressure ventilator to our system. When the bronchi change their aerodynamic resistance to the forced inspiration air flow, because of the constant pressure, the quantity of air entering the lungs will change accordingly.

Pressure however will remain constant in the air piping (because the ventilator in use is a Constant pressure device by definition) and so no air will be delivered by the by-pass connection; not even pressure pulses will act on the water column.

5.2 Preparing the Experiment

Fill the water valve with distilled water via the sliding lateral reservoir up to the level of, say, 10 cm generally recommended in the literature.

Connect the Air-Flow Device to the Controller via the cable provided and the output cable to the recording equipment, see paragraph 4.7.4.

Switch on the ventilator and the recorder.

Branch the "by-pass" connection to respiration piping as indicated in Fig. 1. Keep clamp A tight.

Once the anaesthetized animal is cannulated and the pump is in operation at convenient frequency and volume settings, release the clamp A. Adjust the water level, to cause the water column inside the glass tube to pulsate up and down, so as to let a minute air bubble to escape from the bottom of the tube. You will usually find 7/8 cm of water the ideal physiological condition. The recording equipment will now produce a tracing.

Adjust the "**TIME**" reset knob on the Controller front panel, until the signal is synchronized with breath. See also figure 2, which provides an example of an ideal signal recording.

By clamping the piping in B, all the air delivered by the pump is diverted to the transducer. In this condition, the spike height gives a graphic display of the volume set on the pump, providing a simple means of calibration.

- Keep water valve level on exactly 10 cm
- Set pump at 5ml tidal volume, 70 strokes per minute

6 MAINTENANCE

While any service of the instrument ought to be carried out by Ugo Basile personnel or by qualified personnel authorized by UGO BASILE organization, this section of the instruction manuals describes normal maintenance procedures which can be carried out at your facility.



UNPLUG THE MAINS CORD BEFORE CARRYING OUT ANY MAINTENANCE JOB!

6.1 Electrical

To inspect and/or replace the fuses, **disconnect the mains cable first!** Insert a miniature screwdriver in the slot indentation, see paragraph 4.7.1-Fuse Holder, and snap out the slide which houses the fuses. Use T5A fuses for operation at both 230 or 115 Volts.

Snap in the fuse slide: the mechanical “click” ensures that it is locked.

6.2 Cleaning the Air-Flow Device

The instrument has no moving part and requires practically no maintenance.

To drain the water column, detach the Tygon tube stretch from the water valve nipple.



- **Always use distilled water to fill the valve**, in order to avoid calcium deposits.
- **Do not use organic solvents for cleaning** purposes since they are liable to impair the Perspex surface. Cotton wool dipped in a soapy solution will clean the instrument satisfactorily.
- For **decontamination**, use non-organic disinfectants.
- **Do not clean the air-flow sensor with water.** Pay attention: the transducer must be never get wet.

6.3 Long Inactivity

The instrument does not require any particular maintenance after long inactivity, except cleaning. Protect the instrument from dust when not in use.

6.4 Customer Support

For any further information you may desire concerning the use and/or maintenance of the 17020, please do not hesitate to contact our **service department** (or our local distributor) either directly or via our support page <http://www.ugobasile.com/support.html> :



UGO BASILE s.r.l.

Via G. Di Vittorio 2
21036 GEMONIO – Varese, ITALY



Phone : +39 0332 744574



service@ugobasile.com
logistics@ugobasile.com
sales@ugobasile.com

Before sending any instrument to our factory for repair, please contact our logistics dept. to obtain a return authorization number (RMA) and shipping/packing instructions.

We may not be held responsible for damages during transport due to poor packing; whenever possible, please use the original packing.

7 ORDERING INFORMATION

17020	Bronchospasm Transducer, complete with:
17020-001	Controller
17020-002	Air-Flow Detector
E-WP008	Mains Cord – Europe (or E-WP008-1 U.S.A. / E-WP008-2 U.K.)
E-AU 041	USB pen-drive, including 17020-302 Instruction Manual

7.1 Optional

17308	New DataCapsule-Evo, 4-Channel, 24 bit, 5 kHz Digital Recorder with built-in transducer amplifiers and 4 independent DACs. Including LabScribe3 Recording & Analysis Software, USB Cable
-------	--

8 Instrument Specifications

General

Commands	Time reset, Knob
Power Requirement	Universal input 85-264 VAC, 50-60Hz, 15W max.

Operation

Precision	+/- 0.05 ml Volume
Data Acquisition	17308 optional
Linear Analog Output	0-8V as 0-8ml Volume

Physical

Total Weight	3Kg
Shipping Weight	5Kg approx.
Controller Dimensions	25(w)x26(d)x12(h)cm
Air-Flow Assy. Dimensions	20(w)x20(d)x22(h)cm
Packing Dimensions	68x34x28cm

Warranty	17020 is covered by a 24-month warranty
-----------------	---

9 Bibliography

9.1 Method Paper

- H. Konzett & R. Rössler: "**Versuchsanordnung zu Untersuchungen an der Bronchiàlmuskulatur**" Archiv f. experiment. Pathol. u. Pharmakol 195 (1): 71-74, **1940**

9.2 Papers Dealing With Ugo Basile Bronchospasm Transducer

- K. Ogino et alia: "**PM2.5-Induced Airway Inflammation and Hyperresponsiveness in NC/Nga Mice**" Environmental Toxicol. 10.1002/tox.22303, **2016**
- I. Murakami et alia: "**Rebamipide Suppresses Mite-Induced Asthmatic Responses in NC/Nga Mice**" Am. J. Physiology 309 (8): L872-878, **2015**
- Flora, S. J. S., et al. "**Interactive Effect of Arsenic and Fluoride on Cardio-Respiratory Disorders in Male Rats: Possible Role of Reactive Oxygen Species**" Biometals 24 (4): 615-628, **2011**
- Takahashi, Noriko, et al. "**Direct Inhibition of Arginase Attenuated Airway Allergic Reactions and Inflammation in a Dermatophagoides Farinae-Induced NC/Nga Mouse Model**" Am. J. of Physiology-Lung Cellular & Molecular Physiol. 299.1: L17-L24, **2010**



We do the search for you: we weekly browse bibliography and link new papers to the bibliography section of each UB device.

Don't forget to check our web page periodically for updated bibliography!

Notes

A series of horizontal dashed lines for writing notes.



Notes

A series of 25 horizontal dashed lines for writing notes.



Notes

A series of horizontal dotted lines spanning the width of the page, intended for writing notes.





ugo basile®

TRANSFORMING IDEAS
INTO INSTRUMENTS

CE CONFORMITY STATEMENT

Manufacturer **UGO BASILE srl**
Address Via G. di Vittorio, 2 – 21036 Gemonio, VA, ITALY
Phone n. +39 0332 744574
Fax n. +39 0332 745488

We hereby declare that

Instrument. **BRONCHOSPAM TRANSDUCER**
Catalog number **17020**

*is manufactured in compliance with the following European Union Directives
and relevant harmonized standards*

- *2014/35/UE relating to electrical equipment designed for use within certain voltage limits*
- *2014/30/UE relating to electromagnetic compatibility*
- *2011/65/UE and 2015/863/UE on the restriction of the use of certain hazardous substances in electrical and electronic equipment*

Account Manager

Mauro Uboldi

Nome / Name

October 2018

Date

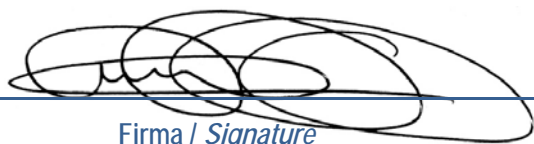

Firma / Signature